

Panels & Adaptors
Page 82



Ventilated Panels
Page 84



Doors & Chassis - Panel Mount
Page 86

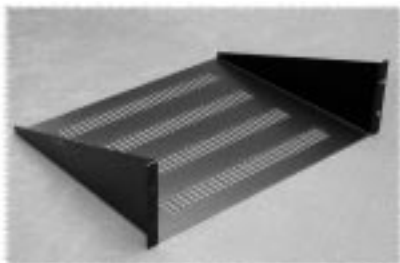

Shelves & Slides
Page 87



Keyboard Shelves
Page 92



Drawers
Page 93

Cable Management
Page 94



Cooling
Page 97



Rack Mount - Outlet Strips
Page 102



Handles
Page 115



Hardware
Page 119



Miscellaneous
Page 121



Panels

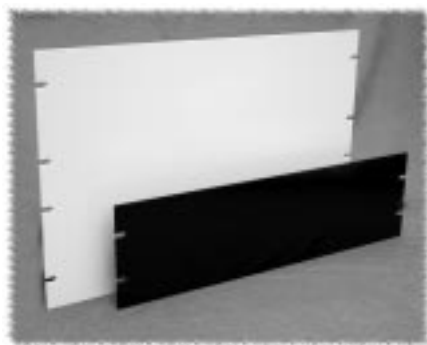

- Standard, flat 19" rack panels
- Choice of either aluminum (lightweight & easy to machine) or steel (stronger & less expensive)
- Painted versions finished in a tough smooth powder paint finish
- Smooth paint finish for easy labelling
- Unfinished aluminum version is white paper covered on one side to protect finish - also used as a surface for a machining template
- Requires mounting hardware

ALUMINUM RACK PANELS (0.125" Thick)

Part Number				Panel Height		No. of Slots
Black Smooth	Beige Smooth	ASA61 Grey Smooth	Unfinished	Inches	Units	
PBPA19001BK2	PBPA19001CG2	PBPA19001GY2	PBPA19001UNF	1.75	1	4
PBPA19003BK2	PBPA19003CG2	PBPA19003GY2	PBPA19003UNF	3.50	2	4
PBPA19005BK2	PBPA19005CG2	PBPA19005GY2	PBPA19005UNF	5.25	3	4
PBPA19007BK2	PBPA19007CG2	PBPA19007GY2	PBPA19007UNF	7.00	4	4
PBPA19008BK2	PBPA19008CG2	PBPA19008GY2	PBPA19008UNF	8.75	5	4
PBPA19010BK2	PBPA19010CG2	PBPA19010GY2	PBPA19010UNF	10.50	6	8
PBPA19012BK2	PBPA19012CG2	PBPA19012GY2	PBPA19012UNF	12.25	7	8
PBPA19014BK2	PBPA19014CG2	PBPA19014GY2	PBPA19014UNF	14.00	8	8
PBPA19015BK2	PBPA19015CG2	PBPA19015GY2	PBPA19015UNF	15.75	9	8
PBPA19017BK2	PBPA19017CG2	PBPA19017GY2	PBPA19017UNF	17.50	10	8
PBPA19019BK2	PBPA19019CG2	PBPA19019GY2	PBPA19019UNF	19.25	11	8
PBPA19021BK2	PBPA19021CG2	PBPA19021GY2	PBPA19021UNF	21.00	12	8
PBPA19022BK2	PBPA19022CG2	PBPA19022GY2	PBPA19022UNF	22.75	13	8
PBPA19024BK2	PBPA19024CG2	PBPA19024GY2	PBPA19024UNF	24.50	14	10
PBPA19026BK2	PBPA19026CG2	PBPA19026GY2	PBPA19026UNF	26.25	15	10
PBPA19028BK2	PBPA19028CG2	PBPA19028GY2	PBPA19028UNF	28.00	16	12
PBPA19029BK2	PBPA19029CG2	PBPA19029GY2	PBPA19029UNF	29.75	17	12
PBPA19031BK2	PBPA19031CG2	PBPA19031GY2	PBPA19031UNF	31.50	18	12

STEEL RACK PANELS (14 Gauge, 0.075" Thick)

Part Number			Panel Height		No. of Slots
Black Smooth	Beige Smooth	ASA61 Grey Smooth	Inches	Units	
PBPS19001BK2	PBPS19001CG2	PBPS19001GY2	1.75	1	4
PBPS19003BK2	PBPS19003CG2	PBPS19003GY2	3.50	2	4
PBPS19005BK2	PBPS19005CG2	PBPS19005GY2	5.25	3	4
PBPS19007BK2	PBPS19007CG2	PBPS19007GY2	7.00	4	4
PBPS19008BK2	PBPS19008CG2	PBPS19008GY2	8.75	5	4
PBPS19010BK2	PBPS19010CG2	PBPS19010GY2	10.50	6	8
PBPS19012BK2	PBPS19012CG2	PBPS19012GY2	12.25	7	8
PBPS19014BK2	PBPS19014CG2	PBPS19014GY2	14.00	8	8
PBPS19015BK2	PBPS19015CG2	PBPS19015GY2	15.75	9	8
PBPS19017BK2	PBPS19017CG2	PBPS19017GY2	17.50	10	8
PBPS19019BK2	PBPS19019CG2	PBPS19019GY2	19.25	11	8
PBPS19021BK2	PBPS19021CG2	PBPS19021GY2	21.00	12	8
PBPS19022BK2	PBPS19022CG2	PBPS19022GY2	22.75	13	8
PBPS19024BK2	PBPS19024CG2	PBPS19024GY2	24.50	14	10
PBPS19026BK2	PBPS19026CG2	PBPS19026GY2	26.25	15	10
PBPS19028BK2	PBPS19028CG2	PBPS19028GY2	28.00	16	12
PBPS19029BK2	PBPS19029CG2	PBPS19029GY2	29.75	17	12
PBPS19031BK2	PBPS19031CG2	PBPS19031GY2	31.50	18	12



- Standard, 19" rack panels
- Lighter and stronger than flat steel panels due to top & bottom fold combined with thinner gauge steel
- Top and bottom fold of 0.50" for added strength
- Tough smooth powder paint finish
- Smooth paint finish for easy labelling
- Requires mounting hardware



FOLDED STEEL RACK PANELS (16 Gauge, 0.060" Thick)

Part Number			Panel Height		No. of Slots
Black Smooth	Beige Smooth	ASA61 Grey Smooth	Inches	Units	
PBFS19001BK2	PBFS19001CG2	PBFS19001GY2	1.75	1	4
PBFS19003BK2	PBFS19003CG2	PBFS19003GY2	3.50	2	4
PBFS19005BK2	PBFS19005CG2	PBFS19005GY2	5.25	3	4
PBFS19007BK2	PBFS19007CG2	PBFS19007GY2	7.00	4	4
PBFS19008BK2	PBFS19008CG2	PBFS19008GY2	8.75	5	4
PBFS19010BK2	PBFS19010CG2	PBFS19010GY2	10.50	6	8
PBFS19012BK2	PBFS19012CG2	PBFS19012GY2	12.25	7	8
PBFS19014BK2	PBFS19014CG2	PBFS19014GY2	14.00	8	8
PBFS19015BK2	PBFS19015CG2	PBFS19015GY2	15.75	9	8
PBFS19017BK2	PBFS19017CG2	PBFS19017GY2	17.50	10	8
PBFS19019BK2	PBFS19019CG2	PBFS19019GY2	19.25	11	8
PBFS19021BK2	PBFS19021CG2	PBFS19021GY2	21.00	12	8
PBFS19022BK2	PBFS19022CG2	PBFS19022GY2	22.75	13	8
PBFS19024BK2	PBFS19024CG2	PBFS19024GY2	24.50	14	10
PBFS19026BK2	PBFS19026CG2	PBFS19026GY2	26.25	15	10
PBFS19028BK2	PBFS19028CG2	PBFS19028GY2	28.00	16	12
PBFS19029BK2	PBFS19029CG2	PBFS19029GY2	29.75	17	12
PBFS19031BK2	PBFS19031CG2	PBFS19031GY2	31.50	18	12

PANEL WIDTH ADAPTORS

- "PA" series converts standard 19" rack panel equipment to 23" rack mount
- "PBAS" series converts standard 19" rack panel equipment to 24" rack mount
- Sold in pairs
- Finished in rugged powder paint
- Standard EIA punched
- Requires mounting hardware



Converts 19" Equipment To 23" Rack Mount

Part Number	Panel Height	
	Inches	Units
PA2319001BK1	1.75	1
PA2319003BK1	3.50	2
PA2319005BK1	5.25	3

Converts 19" Equipment To 24" Rack Mount

Part Number		Panel Height	
Black Smooth	Beige Smooth	Inches	Units
PBAS19001BK2	PBAS19001CG2	1.75	1
PBAS19003BK2	PBAS19003CG2	3.50	2
PBAS19005BK2	PBAS19005CG2	5.25	3
PBAS19007BK2	PBAS19007CG2	7.00	4
PBAS19008BK2	PBAS19008CG2	8.75	5
PBAS19010BK2	PBAS19010CG2	10.50	6
PBAS19012BK2	PBAS19012CG2	12.25	7
PBAS19014BK2	PBAS19014CG2	14.00	8



Ventilated Panels



LOUVERED PANELS

- Standard, 19" rack mount
- Formed 16 gauge steel construction
- Includes a 0.50" fold, top and bottom for added strength
- Designed with 3 columns of 4" wide louvers
- Smooth powder paint finish to match our standard panels
- Louvers face out
- Requires mounting hardware

Part Number		Panel Height		Rows of Louvers
Black Smooth	Beige Smooth	Inches	Units	
PVLL19005BK2	PVLL19005CG2	5.25	3	3
PVLL19007BK2	PVLL19007CG2	7.00	4	4
PVLL19008BK2	PVLL19008CG2	8.75	5	6
PVLL19010BK2	PVLL19010CG2	10.50	6	8
PVLL19012BK2	PVLL19012CG2	12.25	7	10

SLOTTED STEEL PANELS

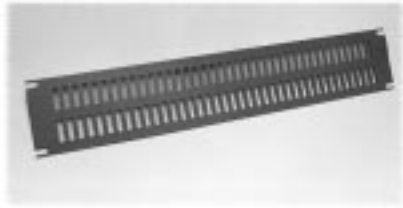

- Standard, 19" rack mount
- 14 gauge steel construction
- Slots are 0.25" x 1.0"
- Smooth powder paint finish to match our standard panels
- Requires mounting hardware

Part Number		Panel Height		Rows of Slots	Open Space (Cubic In.)
Black Smooth	Beige Smooth	Inches	Units		
PVSS19001BK2	PVSS19001CG2	1.75	1	1	9.7
PVSS19003BK2	PVSS19003CG2	3.50	2	2	19.4

SLOTTED ALUMINUM PANELS

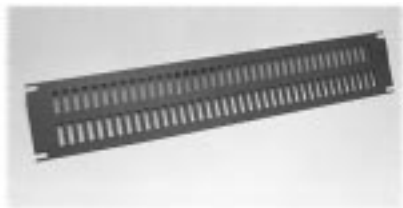

- Standard, 19" rack mount
- 0.13" thick aluminum construction
- Slots are 0.25" x 1.0"
- Smooth powder paint finish to match our standard panels
- Requires mounting hardware

Part Number		Panel Height		Rows of Slots	Open Space (Cubic In.)
Black Smooth	Beige Smooth	Inches	Units		
PVSA19001BK2	PVSA19001CG2	1.75	1	1	9.7
PVSA19003BK2	PVSA19003CG2	3.50	2	2	19.4

PERFORATED ALUMINUM PANELS



- Standard, 19" rack mount
- Folded (for extra strength) - 0.13" thick aluminum construction
- Smooth powder paint finish to match our standard panels
- Requires mounting hardware

Part Number		Panel Height	
Black Smooth	Beige Smooth	Inches	Units
PPFS19001BK2	PPFS19001CG2	1.75	1
PPFS19003BK2	PPFS19003CG2	3.50	2
PPFS19005BK2	PPFS19005CG2	5.25	3
PPFS19007BK2	PPFS19007CG2	7.00	4
PPFS19008BK2	PPFS19008CG2	8.75	5
PPFS19010BK2	PPFS19010CG2	10.50	6

BAFFLE PANEL

- Standard, 19" rack mount
- Rear sloping baffle for directing air flow
- 16 gauge steel construction
- Shown here, upside down to show construction
- Extends apx. 14" behind panel rails
- Smooth black powder paint finish to match our standard panels
- Requires mounting hardware

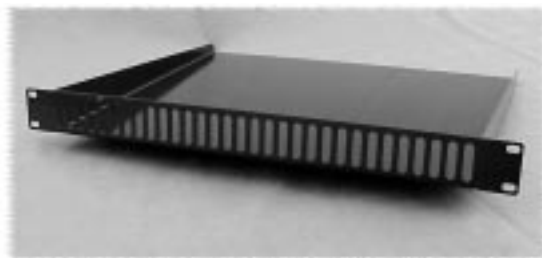

Part Number	Panel Height	
	Inches	Units
PVBB19001BK2	1.75	1

FAN PANELS

- Standard, 19" rack mount
- Create your own 19" rack mount fan or filter fan panels
- Accepts standard square fans (see our cooling accessory section or use your own)
- For a filter fan panel use our filter fan grills (see our cooling accessory section)
- Perfect as an intake fan panel (when using "push-pull" cooling use the fan grill panel below for exhaust)
- Rugged textured black powder paint
- Requires mounting hardware
- Control your rack temperature with our economical, compact thermostat (see our cooling accessory section)

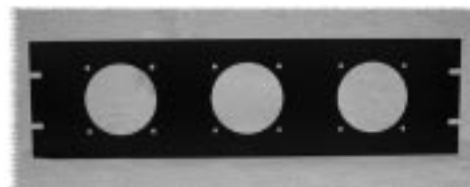

Part Number	Number of Fan Holes	Accepts Fan Size	Panel Height	
			Inches	Units
PPFP190802BK1	2	3.15"	5.25	3
PPFP190803BK1	3	3.15"	5.25	3
PPFP191202BK1	2	4.7"	7.00	4

FAN GRILL PANELS

- Standard, 19" rack mount
- Create your own 19" rack mount fan panels
- Accepts standard square fans 4.7" (120 mm) see our cooling accessory section or use your own)
- Perfect for an exhaust fan panel (when using "push-pull" cooling use the fan panel above with filter grills for intake)
- Rugged textured black powder paint
- Requires mounting hardware
- Control your rack temperature with our economical, compact thermostat (see our cooling accessory section)



Part Number	Number of Fan Holes	Accepts Fan Size	Panel Height	
			Inches	Units
PPGP191202BK1	2	4.7"	5.25	3



Doors & Chassis - Panel Mount

HINGED FLAT DOOR PANELS

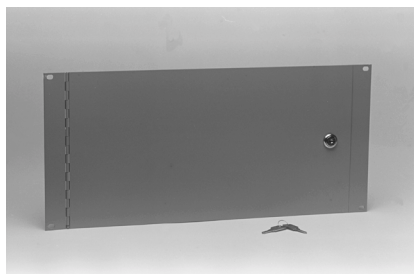

- Standard, 19" rack mount
- 14 gauge steel construction
- Door opening is 16.2" wide
- Includes lock, hasp & 2 keys
- Smooth powder paint finish to match our standard panels
- Requires mounting hardware

Part Number		Panel Height	
Black Smooth	Beige Smooth	Inches	Units
PHPF19005BK2	PHPF19005CG2	5.25	3
PHPF19008BK2	PHPF19008CG2	8.75	5
PHPF19012BK2	PHPF19012CG2	12.25	7

HINGED PANEL RAIL DOOR



- Standard, 19" rack mount
- Formed 14 gauge steel construction, folded on all four sides
- Hinges bolt directly to panel rail (door depth of 0.63")
- When door is open, space between panel rails is completely accessible
- Includes lock, hasp & 2 keys
- Smooth powder paint finish to match our standard panels
- Requires mounting hardware

Part Number		Panel Height	
Black Smooth	Beige Smooth	Inches	Units
RSDP19010BK2	RSDP19010CG2	10.50	6
RSDP19012BK2	RSDP19012CG2	12.25	7
RSDP19014BK2	RSDP19014CG2	14.00	8
RSDP19017BK2	RSDP19017CG2	17.50	10
RSDP19022BK2	RSDP19022CG2	22.75	13
RSDP19028BK2	RSDP19028CG2	28.00	16

STEEL CHASSIS WITH PANEL



- Standard, 19" rack mount
- Formed 16 gauge steel construction
- Chassis measures 17" wide x 3" deep
- Panel (included) mounts over chassis
- Smooth powder paint finish to match our standard panels
- Requires mounting hardware

Part Number		Panel Height		Chassis Height (In.)
Beige Textured	Grey Smooth	Inches	Units	
5-350DCG1	5-350DGY2	3.50	2	3.1
5-525DCG1	5-525DGY2	5.25	3	4.9

ALUMINUM CHASSIS

- Standard, 19" rack mount
- 0.06" thick aluminum construction
- Chassis measures 17" wide x 5.25" deep
- Natural finish aluminum
- Requires mounting hardware

Part Number	Panel Height	
	Inches	Units
7-350D	3.50	2
7-525D	5.25	3



Accessories

RAIL MOUNT - DUAL MODEM SHELVES

- Standard 19" rack mount - overall 19.5" deep, uses 3.5" (2U) of panel space
- Dual modem shelf permits front and rear access to modems on open relay racks
- Unvented version (pictured) available in either 19" or 23" rack panel width
- 16 gauge steel construction, weight load tested to 200 pounds
- The vented version provides a sturdy shelf without obstructing upward heat movement
- Powder paint finish
- Requires mounting hardware

Unvented

Part Number		Panel Width
Black Textured	Grey Smooth	
DNDMS19BK1	DNDMS19GY2	19"
DNDMS23BK1	-	23"



Vented

Part Number		Panel Width
Black Textured	Grey Smooth	
DNDMV19BK1	DNDMV19GY2	19"

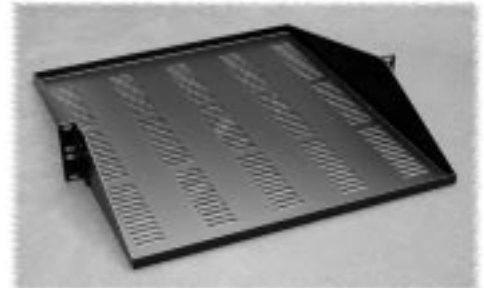

RAIL MOUNT SHELVES

- Standard 19" rack mount - rail mount
- 17.25" wide and uses 5.25" (3U) of panel space, choice of two depths, either 15" or 20"
- 14 gauge steel construction, weight load tested to 200 pounds (unvented), 200 pounds (vented)
- Mounts to front rail either as an internal shelf or external shelf/work area
- The vented version provides a sturdy shelf without obstructing upward heat movement
- Powder paint finish
- Requires mounting hardware

Unvented

Part Number			Panel Width	Shelf Depth
Black Textured	Beige Textured	Grey Smooth		
RASU190515BK1	RASU190515CG1	RASU190515GY2	19"	15"
RASU190520BK1	RASU190520CG1	-	19"	20"
RASU230515BK1	-	-	23"	15"
RASU230520BK1	-	-	23"	20"

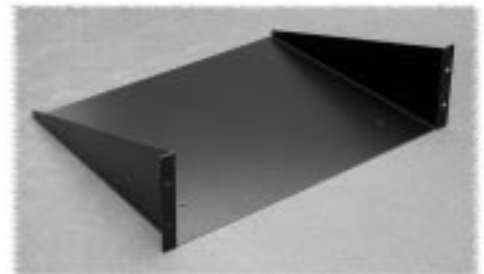

Vented

Part Number			Panel Width	Shelf Depth
Black Textured	Beige Textured	Grey Smooth		
RASV190515BK1	RASV190515CG1	RASV190515GY2	19"	15"
RASV190520BK1	RASV190520CG1	-	19"	20"
RASV230515BK1	-	-	23"	15"
RASV230520BK1	-	-	23"	20"

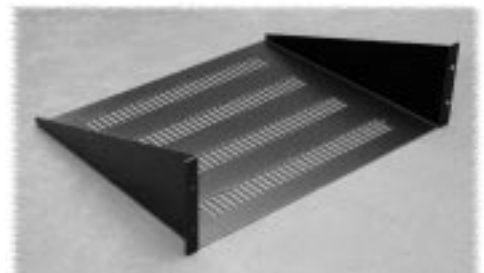

Shelves & Slides - Panel Mount

RAIL MOUNT KEYBOARD/MONITOR SHELF



- Standard 19" rack mount
- Mounts to panel rails using 5.25" (3U) of vertical panel space
- Extends 15" back from front panel
- Slanted keyboard section is 8.5"
- Rear lip to reduce chance of monitor being pushed off rear of shelf
- Available in either 19" or 23" rack panel width
- 14 Ga. steel construction
- Weight load tested to 160 pounds
- Finished in rugged black textured powder paint
- Requires mounting hardware

Part Number	Panel Width
RKBM19BK1	19"
RKBM23BK1	23"

ADJUSTABLE SHELF

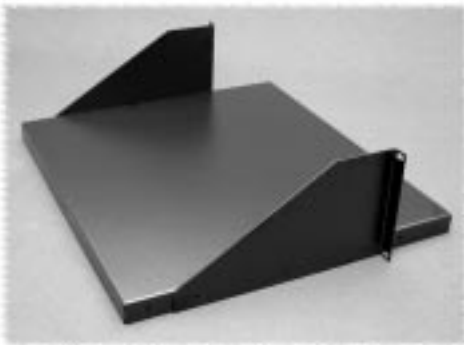

- Standard 19" rack mount
- Mounts to panel rails using 5.25" (3U) of vertical panel space
- Separate, reversible side brackets for maximum flexibility (allows shelf to extend inside or outside the rack)
- 4 different depth settings (depending on location of side brackets)
- 14 Ga. steel construction, finished in rugged black textured powder paint
- Requires mounting hardware

Part Number	Panel Width	Shelf Depth
DNRMA1916BK1	19"	16"
DNRMA1920BK1	19"	20"
DNRMA2316BK1	23"	16"
DNRMA2320BK1	23"	20"

RAIL MOUNT EQUIPMENT SHELF



- Standard 19" rack mount
- A closed shelf with 1.5" dia. holes in each bottom corner for cord access
- Fabricated from 18 gauge steel
- Inside dimensions 17.2" wide x 15" deep
- Weight load tested to 75 pounds
- Opening height is only 1" less than panel height
- Finished in white (to aid visibility), powder paint
- Requires mounting hardware

Part Number	Panel Height
White Smooth	
RASE1900815WH2	8.75"
RASE1901015WH2	10.50"
RASE1901215WH2	12.25"

Shelves - Dual Pair Rail Mount

FIXED SHELVES

- Heavy duty, 14 Ga. steel construction, folded edges on all four sides for extra strength
- The vented version provides a sturdy shelf without obstructing upward heat movement
- Weight load tested to 350 pounds
- Sides folded up for easy hardware installation from above the shelf
- Sides are slotted for easy adjustment with most rail depth locations
- Rugged textured powder paint finish
- If used with our square hole rails you will need to order P/N **CPRSA** rail adaptor for each shelf ordered
- **MOUNTS ON TWO PAIR OF MOUNTING RAILS (FRONT & BACK)**

Part Number		Shelf Type	Shelf Depth
Black Textured	Beige Textured		
19" Width			
RFVS1918BK1	RFVS1918CG1	Vented	18"
RFVS1921BK1	RFVS1921CG1	Vented	21"
RFVS1926BK1	RFVS1926CG1	Vented	26"
RFVS1931BK1	RFVS1931CG1	Vented	31"
RFUS1918BK1	RFUS1918CG1	Unvented	18"
RFUS1921BK1	RFUS1921CG1	Unvented	21"
RFUS1926BK1	RFUS1926CG1	Unvented	26"
RFUS1931BK1	RFUS1931CG1	Unvented	31"
24" Width			
RFVS2418BK1	RFVS2418CG1	Vented	18"
RFVS2421BK1	RFVS2421CG1	Vented	21"
RFVS2426BK1	RFVS2426CG1	Vented	26"
RFVS2431BK1	RFVS2431CG1	Vented	31"
RFUS2418BK1	RFUS2418CG1	Unvented	18"
RFUS2421BK1	RFUS2421CG1	Unvented	21"
RFUS2426BK1	RFUS2426CG1	Unvented	26"
RFUS2431BK1	RFUS2431CG1	Unvented	31"

Vented

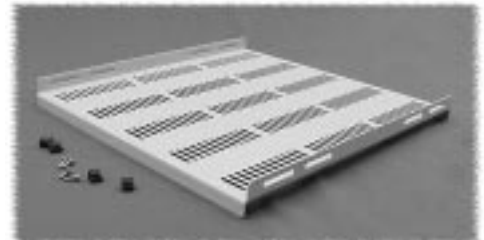

Unvented



SLIDING SHELVES

- Heavy duty, 14 Ga. steel construction, folded edges on all four sides for extra strength
- The vented version provides a sturdy shelf without obstructing upward heat movement
- Weight load tested to 120 pounds
- Slides are slotted for easy adjustment with most rail depth locations
- Rugged textured powder paint finish

Part Number		Shelf Type	Shelf Depth
Black Textured	Beige Textured		
19" Width			
RSVS1918BK1	RSVS1918CG1	Vented	18"
RSVS1921BK1	RSVS1921CG1	Vented	21"
RSVS1926BK1	RSVS1926CG1	Vented	26"
RSVS1931BK1	RSVS1931CG1	Vented	31"
RSUS1918BK1	RSUS1918CG1	Unvented	18"
RSUS1921BK1	RSUS1921CG1	Unvented	21"
RSUS1926BK1	RSUS1926CG1	Unvented	26"
RSUS1931BK1	RSUS1931CG1	Unvented	31"
24" Width			
RSVS2418BK1	RSVS2418CG1	Vented	18"
RSVS2421BK1	RSVS2421CG1	Vented	21"
RSVS2426BK1	RSVS2426CG1	Vented	26"
RSVS2431BK1	RSVS2431CG1	Vented	31"
RSUS2418BK1	RSUS2418CG1	Unvented	18"
RSUS2421BK1	RSUS2421CG1	Unvented	21"
RSUS2426BK1	RSUS2426CG1	Unvented	26"
RSUS2431BK1	RSUS2431CG1	Unvented	31"

Vented



Unvented

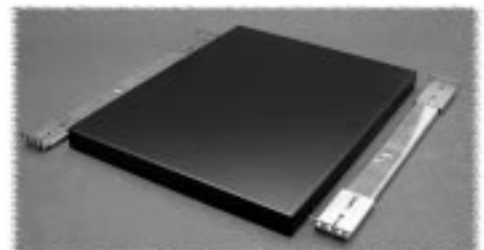

Accessories



Hammond Manufacturing Co. Ltd.
394 Edinburgh Rd. North
Guelph, Ontario N1H 1E5 CANADA
© Phone: 519-822-2960 Fax: 519-822-0715



Hammond Manufacturing Co. Inc.
256 Sonwil Dr.
Cheektowaga, NY 14225 USA
Phone: 716-651-0086 Fax: 716-651-0726

Shelves & Slides - Dual Pair Rail Mount

FIXED CHASSIS/SHELF

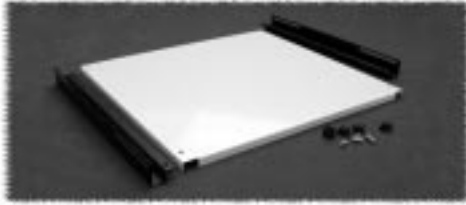

- Shelf can be used as a permanently mounted support shelf or as a pull out chassis
- Will also accept type "RSLIDE" equipment slides (see below) for pull out applications
- If used with our square hole rails you will need to order P/N **CPRSA** rail adaptor for each shelf ordered
- 18-gauge steel shelf and 14-gauge brackets
- Weight load tested to 85 pounds
- Shelf is 16.8" wide and 0.5" high
- Finished in white powder paint for high visibility
- **MOUNTS ON TWO PAIR OF MOUNTING RAILS (FRONT & BACK)**

Part Number	Shelf Depth	Bracket Depth
19" Width		
RASC1912WH2	11.9"	13.2"
RASC1916WH2	15.9"	14.9"
RASC1922WH2	21.9"	20.9"
24" Width		
RASC2412WH2	11.9"	13.2"
RASC2416WH2	15.9"	14.9"
RASC2422WH2	21.9"	20.9"

EQUIPMENT SLIDES

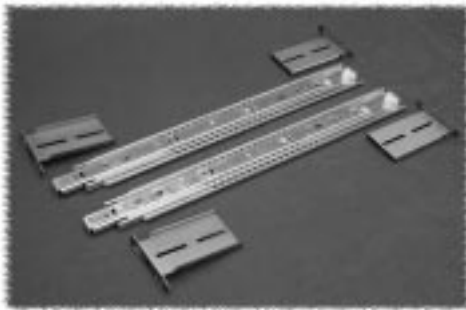

- **SOLD IN PAIRS**
- Slide travel equals length plus 1"
- Heavy duty - double rail, ball bearing type
- Requires mounting hardware
- **MOUNTS ON TWO PAIR OF MOUNTING RAILS (FRONT & BACK)**

Part Number	Length	Capacity (Pair)
RSLIDE12	12"	120#
RSLIDE16	16"	130#
RSLIDE22	22"	120#

EQUIPMENT SIDE SUPPORT ANGLES

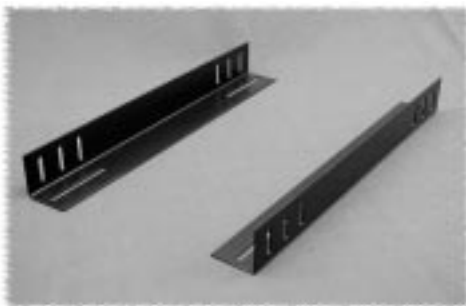

- **SOLD IN PAIRS**
- Angles mount along side of rack to both front & rear rack mounting rails
- Supplies side support for heavy equipment (relieving stress from the front panel) or as an aid in installation of deep equipment
- Slots allow up/down and front/back adjustments
- Made of 14 gauge steel, with dimensions of 1.75" x 1.75"
- Finished in rugged textured black powder paint
- Requires mounting hardware
- If used with our square hole rails you will need to order P/N **CPRSA** rail adaptor for each support pair ordered
- **MOUNTS ON TWO PAIR OF MOUNTING RAILS (FRONT & BACK)**

Part Number	Length
RASA12BK3	9.97"
RASA16BK3	14.95"
RASA22BK3	20.95"
RASA28BK3	28.00"

REAR SUPPORT BAR

- Standard 19" rack mountable
- Heavy duty 14 gauge steel support mounts to rear rack rails
- Supports the rear of heavy or deep equipment (relieving stress from the front panel and/or as an aid for equipment mounting & removing)
- Folded top edge for extra deep edge & extra strength
- Uses only 1U (1.75") of panel space
- Includes slots for easy installation of cable ties or velcro belts for cable organizing
- Rugged textured black powder paint finish
- Requires panel mounting hardware



Part Number	Length
RASB19BK1	19"

EQUIPMENT HOLD DOWN BRACKETS

- Standard 19" & 23" rack mountable
- Designed mainly for our relay racks but can be used on any rack
- Heavy duty 16 gauge steel bracket fastens between rails for support across equipment
- Perfect for stabilizing shelf mounted P.C. towers & monitors
- Uses only 1U (1.75") of panel space
- Includes slots for easy installation of cable ties or velcro belts for cable organizing in between brackets
- Includes four hold down brackets (enough for two side by side towers)
- Includes rubber bracket feet to keep from marking equipment
- Rugged textured black powder paint finish
- Includes mounting hardware

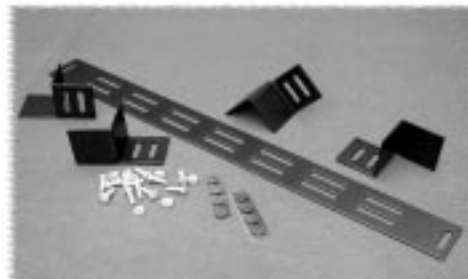

Part Number	Panel Width
DNTB19BK1	19"
DNTB23BK1	23"



SQUARE HOLE PANEL RAIL ADAPTOR

- Used in conjunction with square hole panel rails to allow use of dual rail mount accessories
- Use with our RASA, RASC, RFUS, RFVS series accessories
- Set of four
- Includes mounting hardware
- Rugged textured black powder paint finish



Part Number	Adapts
CPRSA	1 Shelf



Keyboard Shelves

RAIL MOUNT KEYBOARD/MONITOR SHELF



- Standard 19" rack mount
- Mounts to panel rails using 5.25" (3U) of vertical panel space
- Extends 15" back from front panel
- Slanted keyboard section is 8.5"
- Rear lip to reduce chance of monitor being pushed off rear of shelf
- Available in either 19" or 23" rack panel width
- 14 Ga. steel construction
- Weight load tested to 160 pounds
- Finished in rugged black textured powder paint
- Requires mounting hardware



Part Number	Panel Width
RKBM19BK1	19"
RKBM23BK1	23"

KEYBOARD DRAWER (DUAL RAIL MOUNT)

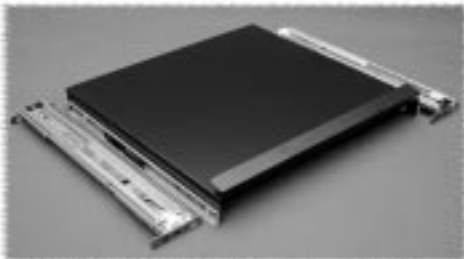

- Standard 19" or 24" rack mount
- Supplied as shown complete with two slides and mounting hardware
- Mounts to front & rear panel rails of racks
- Uses only 3.5" (2U) of panel space
- Weight load tested to 120 pounds
- Unique design maximizes available space between rails (17.77")
- Rugged textured black powder paint finish
- **MOUNTS ON TWO PAIR OF MOUNTING RAILS (FRONT & BACK)**

Part Number	Panel Width	Shelf Depth
RAKS19BK1	19"	15"
RAKS24BK1	24"	15"

SWIVEL KEYBOARD DRAWER (DUAL RAIL MOUNT)



- Standard 19" rack mount
- Supplied complete with two slides and mounting hardware (keyboard not included)
- Mounts to front & rear rack mount rails
- Uses only 5.25" (3U) of panel space
- Unique design allows the use of full size keyboards (not included) in a 19" rack
- Top tray of drawer swivels clockwise 90 degrees, once pulled outside the front of the rack.
- Rugged textured black powder paint finish
- **MOUNTS ON TWO PAIR OF MOUNTING RAILS (FRONT & BACK)**

Part Number	Panel Width	Shelf Depth
RSKS19005BK1	19"	15"

Keyboard Access Door & Drawers

KEYBOARD DRAWER ACCESS DOOR

- Standard 19" rack mount
- Restricts access to keyboard drawers
- Mounts to front panel rails in front of keyboard drawer (RAKS & RSKS series - see previous page)
- Includes all mounting hardware and 2 keys
- Uses only 5.25" (3U) of panel space
- Rugged textured black powder paint finish

Part Number	Panel Width
RSKS19DOORBK1	19"

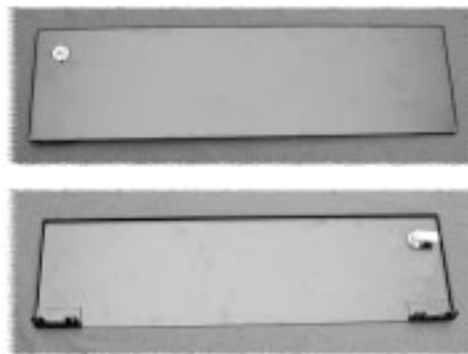

RAIL MOUNT STORAGE DRAWERS

- Standard 19" rack mount, available in 3 depths
- Plastic front pull handle
- Complete drawer with slides, hardware, lock & two keys
- Drawer shroud, 14 Ga. steel construction
- Rear support brackets included for all depths or can be supported from rear accessory rail - weight load tested to 120 pounds
- Drawer interior smooth white powder paint for high visibility
- Front face finished in tough textured powder paint
- **MOUNTS ON TWO PAIR OF MOUNTING RAILS (FRONT & BACK)**



12" Deep

Part Number		Drawer Height
Black Textured	Beige Textured	
RDRW1900312BK1	RDRW1900312CG1	3.50"
RDRW1900512BK1	RDRW1900512CG1	5.25"
RDRW1900712BK1	RDRW1900712CG1	7.00"
RDRW1900812BK1	RDRW1900812CG1	8.75"
RDRW1901212BK1	RDRW1901212CG1	12.25"

16" Deep

Part Number		Drawer Height
Black Textured	Beige Textured	
RDRW1900316BK1	RDRW1900316CG1	3.50"
RDRW1900516BK1	RDRW1900516CG1	5.25"
RDRW1900716BK1	RDRW1900716CG1	7.00"
RDRW1900816BK1	RDRW1900816CG1	8.75"
RDRW1901216BK1	RDRW1901216CG1	12.25"

22" Deep

Part Number		Drawer Height
Black Textured	Beige Textured	
RDRW1900322BK1	RDRW1900322CG1	3.50"
RDRW1900522BK1	RDRW1900522CG1	5.25"
RDRW1900722BK1	RDRW1900722CG1	7.00"
RDRW1900822BK1	RDRW1900822CG1	8.75"
RDRW1901222BK1	RDRW1901222CG1	12.25"



Cable Management (Horizontal)

STEEL RING PANELS



- Standard 19" or 23" rack mount
- Five steel rings welded to a folded (for extra strength) rack panel
- Rings extend 3.5" from panel front
- Rugged textured black powder paint finish
- Requires mounting hardware

Part Number	Panel Width	Panel Height	
		Inches	Units
PCMBS19001BK1	19	1.75	1
PCMBS19003BK1	19	3.50	2
PCMBS23001BK1	23	1.75	1
PCMBS23003BK1	23	3.50	2

VELCRO STRAP PANELS



- Standard 19" or 23" rack mount
- Five velcro strap panel, folded (for extra strength)
- Includes five velcro straps
- Rugged textured black powder paint finish
- Requires mounting hardware

Part Number	Panel Width	Panel Height	
		Inches	Units
PCMBV19001BK1	19	1.75	1
PCMBV23001BK1	23	1.75	1

METAL FINGER PANELS

Front View (Door Open)



- Standard 19" rack mount
- Snap open, hinged rear door
- Rack mount side has five slotted openings
- Extends 3" (not including snap door buttons) from rack rails
- Rugged textured black powder paint finish
- Requires mounting hardware

Rear View (Rack Mount Side)

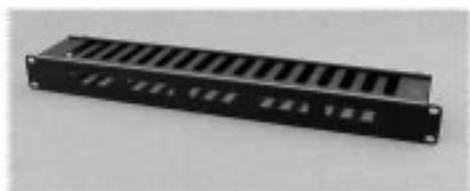

Part Number	Panel Height	
	Inches	Units
PCMDS19001BK1	1.75	1
PCMDS19003BK1	3.50	2
PCMDS19005BK1	5.25	3

HINGED CABLE GUIDE

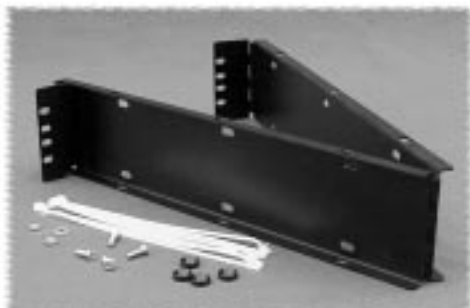

- Mounts to standard 19" rack rails
- Steel construction
- Includes mounting hardware & tie wraps
- Rugged textured black powder paint finish

Part Number	Panel Height	
	Inches	Units
CGUIDE	3.50	2

Cable Management (Horizontal)

METAL ENCLOSED PANEL

- Standard 19" rack mount
- Continuous hinged door with magnetic closure strip
- Four 3.5" x 0.75" oblong openings top & bottom - allowing for cable exit top and/or bottom
- Extends 1.88" from rack rails
- Rugged textured black powder paint finish
- Requires mounting hardware

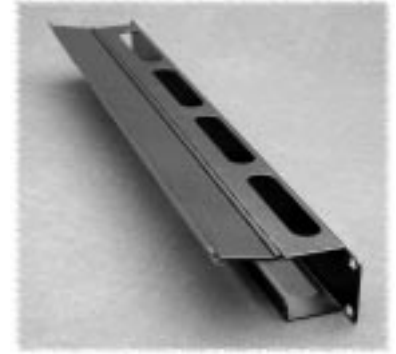

Part Number	Panel Width	Height	
		Inches	Units
PCMDE19001BK1	19"	1.75	1
PCMDE19003BK1	19"	3.00	2

Front View (Door Closed)

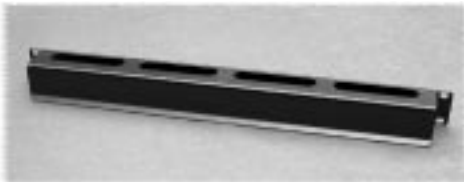

Rear View (Rack Mount Side)



CABLE TROUGH

- Choice of 19" or 23" rack mount
- Provides support for horizontal runs of heavy cable bundles
- Uses 3.5" (2U) of panel space
- Rugged textured black powder paint finish
- Requires mounting hardware



Part Number	Panel Width
PCMT19003BK1	19"
PCMT23003BK1	23"

VELCRO STRAP KIT

- Perfect for bundling cables where repeated changes are required or to avoid over compression of cables from plastic cable ties
- Package of five velcro straps
- 1" wide, 12" long strap
- Holds a maximum of 3.5" diameter bundle
- Black velcro straps with buckle
- Part Number **CMSTRAP5**



CABLE ACCESS PANEL

- Standard 19" rack mount
- Formed 16 gauge steel construction
- 15" x 2" cutout opening, with a protected edge
- Allows for easy entry of cables through 19" panel opening
- Rugged textured powder paint finish
- Requires mounting hardware

Part Number		Panel Height	
Black Textured	Grey/Beige	Inches	Units
DNCE19BK1	DNCE19CG1	3.5	2

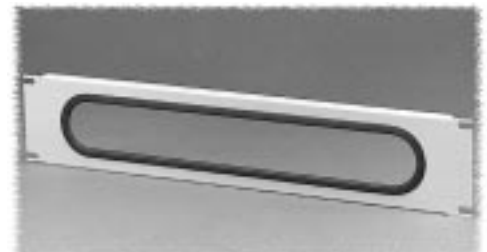

Accessories



Hammond Manufacturing Co. Ltd.
394 Edinburgh Rd. North
Guelph, Ontario N1H 1E5 CANADA
© Phone: 519-822-2960 Fax: 519-822-0715



Hammond Manufacturing Co. Inc.
256 Sonwil Dr.
Cheektowaga, NY 14225 USA
Phone: 716-651-0086 Fax: 716-651-0726

Cable Management (Vertical)



SINGLE CABLE RING

- Mounts to standard 19" rack rails & relay racks
- Steel construction
- 3.5" long X 1.25" wide
- Rugged textured black powder paint finish
- Requires mounting hardware

Part Number	Panel Height	
	Inches	Units
CMRBK1	1.75	1
CMR3BK1	3.50	2

VERTICAL CABLE ORGANIZER



- Mounts to depth amhal rack struts, vertically inside rack cabinet
- Used on 24" 19" Extra Wide rack cabinets so as not to interfere with rack mounted equipment
- Heavy duty - steel body with steel hinged door and 5" plastic pull handle
- Door includes full height magnetic closure strip
- Rounded openings are 3" x 2" - allowing for cable exit from sides and/or back of organizer
- Extends 2.5" from amhal struts
- Includes strut mounting hardware
- Rugged black powder paint finish

Part Number	Panel Height	
	Inches	Units
VCMD570BK1	70.00	40
VCMD578BK1	78.75	45

Door Closed



Door Open



VERTICAL CABLE ORGANIZER

- Mounts to depth amhal rack struts, vertically inside rack cabinet
- Low profile - designed for use on 19" rack cabinets so as not to interfere with rack mounted equipment
- Heavy duty - 16 gauge steel
- Rounded openings are 2" x 2" - allowing for cable exit from sides and/or back of organizer along with 1.5" oblong cable tie-off cutouts
- Extends only 0.5" from amhal struts
- Includes strut mounting hardware
- Rugged black powder paint finish

Part Number	Panel Height	
	Inches	Units
VCT70	70.00	40
VCT78	78.75	45



Top End View

Cooling - General Selection

Specifications

All Hammond blowers and filter fans are engineered for performance and built for reliability. This versatile line includes blowers, fan trays and filter fans.

Blowers and fans use forced convection cooling, which means ambient air flows through a filter into the enclosure to cool heated components. Both blowers and fans are sized in CFM (cubic feet per minute).

It is recommended that an exhaust filter be used in combination with the blower or filter fan to act both as an exhaust point for the hot internal air plus aid in the pressurization of the enclosure, reducing the chance of unfiltered air entering the enclosure. Whenever possible, the blower or filter fan should be located in the bottom third of the enclosure and the filtered exhaust grill placed as high as possible on the opposing side. Performance levels can be further increased by adding a second exhaust filter.

Sizing Blowers and Fans

To determine the CFM (cubic feet per minute) required in any standard situation, use the following calculation, (non-standard situations would consist of high air density – significantly more than 0.075 lbs. per cubic foot.)

$$\text{C.F.M.} = \frac{\text{Power to be dissipated (Watts)} \times 3.17}{\text{Maximum Allowable Internal Temperature (°F)} - \text{Maximum Ambient Temperature(°F)}}$$

Note: The calculation above is exact, but adding an additional 25% to the CFM level is a standard safety factor. If the air density is high (significantly more than 0.075 lbs. per cubic foot), use the number calculated above in the following formula:

$$\frac{\text{CFM} \times (0.075)}{\text{Non-standard air Air Density (lbs per cubic foot)}}$$

Note: Ambient Temperature must be lower than maximum internal temperature for fan/blower to be effective.

THERMOSTAT

- Designed to provide air temperature control and monitoring in cabinets
- Thermostat NO (Normally Open) for control of cooling equipment, or for switching signal transmitters in case of overheating
- Thermostatic bi-metal sensor element
- Available in Fahrenheit (Part Number **SKT011419NO**) or in Celsius (Part Number **SKT011419NO-C**)
- Compact 2.4" High x 1.3" Wide x 1.4" Deep, gray ABS flame retardant plastic (UL94VO)
- 2 pole terminal for AWG 14 wire
- Switching capacity of 15A (120VAC) or 10A (250VAC)
- Temperature range from 30-140 degrees F
- cUR & UR & CE listed



FAN & BLOWER FILTER COAT

- Provides a filter adhesive with a grease like consistency which absorbs and traps dust particles
- 10 oz. bottle with environmentally friendly trigger spray
- Part Number **1475Q**



FANS (TUBEAXIAL)



- Choice of 4.70" (120mm) or 3.15" (80mm)
- 1.50" deep
- Choice of either 115 or 230 VAC, 50/60 Hz.
- Impedance protected motor
- Class-B insulated
- Ball bearing construction, metal blades
- Diecast aluminum body
- Rotation is counter clockwise (looking at the rotor - as pictured)
- Airflow is over the struts (out the back as pictured)
- 4.70" (120 mm) fans have male plug terminations (requires fan cords below)
- 3.15" (80 mm) fans have 11" long lead wires
- UL recognized, CSA listed, CE certified
- With mounting hardware



115 VAC Fans

Part Number	Size		CFM	Use With Fan Guard Part Number	Use with Filter Grill Part Number
	Inches	mm			
FAN80AC115	3.15	80	32	FAN80FG	XPFA80...
DNMF100AC115	4.70	120	100	DNFG	XPFA120...

230 VAC Fans

Part Number	Size		CFM	Use With Fan Guard Part Number	Use with Filter Grill Part Number
	Inches	mm			
FAN80AC230	3.15	80	32	FAN80FG	XPFA80...
DNMF100AC230	4.70	120	100	DNFG	XPFA120...

FAN CORDS



- For 115 VAC wiring
- Save time with these stock fan cords
- Molded female fan plug (0.91" x 0.68")

Part Number	Description	Lead Length	Fan Connector	115VAC Plug
DNMFC	Single Fan Cord	24"	Straight	No
DNFC48P	Single Fan Cord	48"	45 degree	Yes
DNFC72P	Single Fan Cord	72"	45 degree	Yes
DNFCDC2P	Daisy Chain	24"	Qty. 2- 45 degree, 24" apart	Yes
DNFCDC3P	Daisy Chain	24"	Qty 3 - 45 degree, 24" apart	Yes

FILTER FAN GRILLS

- Create your own filter fans or exhaust grills
- Mounts easily with 4 screws using template and hardware provided
- Complete with flame retardant ABS plastic grill and flame retardant synthetic filter
- Integral gasket on rear of grill (see photo below), seals against mounting surface
- Can be used with standard 3.15" (80 mm) or 4.7" (120 mm) square fans (available opposite page or use your own) or alone as an exhaust grill
- Molded in a choice of 3 colors to match our racks & accessories

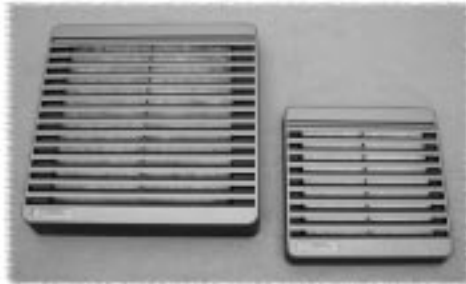

Two Sizes



Open View



Assembled
(fan not included)



Rear View

Part Number			Grill Size		Use with Square Fan Size
Black	Beige	Grey	H	W	
XPFA80BK	XPFA80CG	XPFA80GY	4.13"	4.13"	3.15"
XPFA120BK	XPFA120CG	XPFA120GY	5.91"	5.91"	4.70"

REPLACEMENT FILTERS

- Flame retardant synthetic filter (as supplied with above)
- Five per pack

Part Number	Use with Square Fan Size
PFF1000	3.15" (XPFA80 series)
PFF2000	4.7" (XPFA120 series)

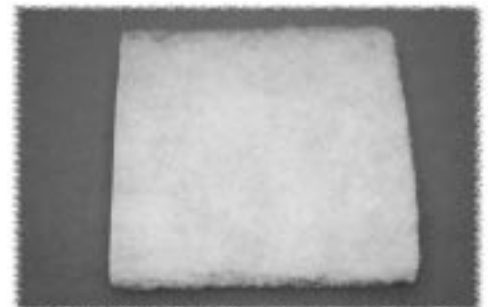

FAN FINGER GUARDS

- Mounts to either the 3.15" (80 mm) or 4.7" (120 mm) fans
- Steel construction
- Chrome plated finish
- Includes mounting hardware

Part Number	Description	Use with Fan Size
FAN80FG	Wire mesh, nickel plated	3.15"
DNFG	Wire mesh, nickel plated	4.70"

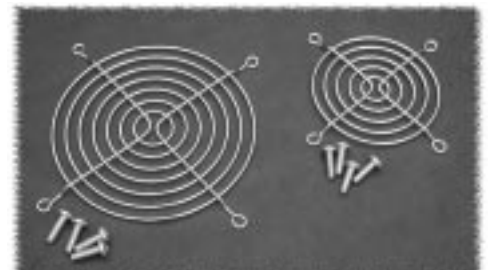

FAN TRAYS

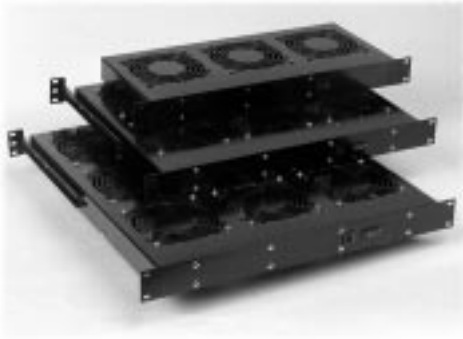

- Standard 19" rack mount
- Compact and economical rack cooling solution
- Fan trays can be positioned at the bottom of a rack to force air through the cabinet, at the top to exhaust air out or below specific pieces of equipment for spot cooling
- 115VAC 50/60 Hz., thermally protected, ball bearing fans
UR/cUR listed
- Circuit breaker protected
- Low profile 1.75" (1U) of panel space
- 6' 14/3 STJW cord with molded 3 prong plug included
- Integral finger guards above and below fans
- Case width is 17"
- 6 and 9 fan units include an adjustable rear mounting bracket (mounts to rear panel rails) for extra stability
- Shipped fully assembled
- Available with or without on/off switch
- Finished in smooth black powder paint
- Control your rack temperature with our economical, compact thermostat

FT900HA1BK

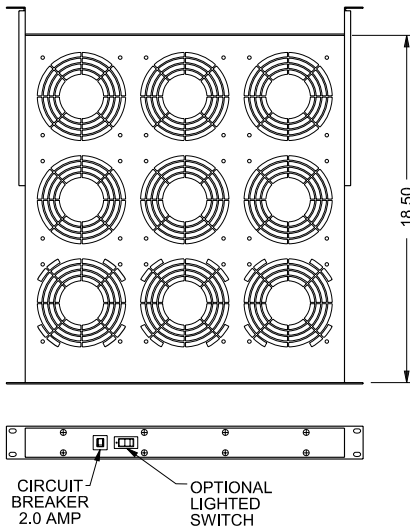

FT600HA1BK

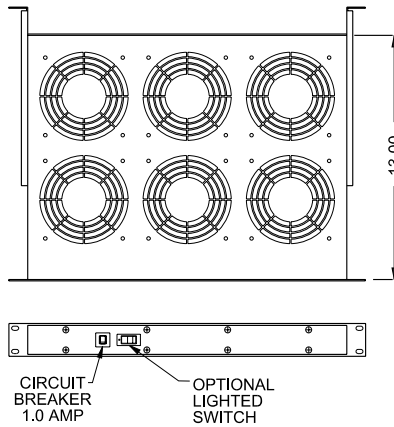

FT300HA1BK

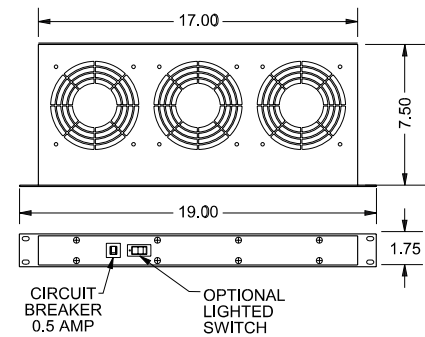

Part Number		CFM	Running Amps	Watts	Panel Width	Case Width	Case Depth	Rear Bracket Depth	
Without Switch	With Lighted Switch							Min.	Max.
FT300TA1BK	FT300HA1BK	300	0.5	40	19	17	7.5	n/a	n/a
FT600TA1BK	FT600HA1BK	600	1.0	80	19	17	13	2.40	19.20
FT900TA1BK	FT900HA1BK	900	1.5	120	19	17	18.5	7.90	24.70

PACKAGED TWIN BLOWERS

- Standard 19" rack mount
- All blowers contain a quadruplex centrifugal blower powered by a single precision ball-bearing motor
- These widely used packaged twin blowers deliver air from more than 50% of their 17" width
- 115VAC 50/60 Hz., UR/CSA listed ball bearing motor
- Internal neoprene isolation mounts reduce transmission of vibration to the enclosure
- Heavy duty steel enclosure
- Includes permanent filter & attractive stainless steel grill
- Inlet air (front of unit) cools motor for long life
- Exhaust guards included
- Six foot (minimum) SJTW 3-wire cord



KP350A

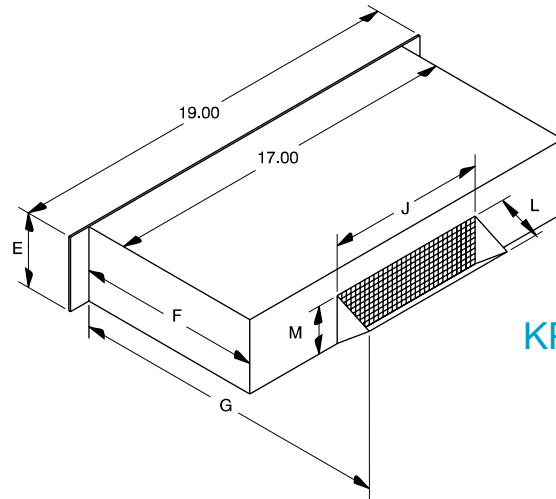
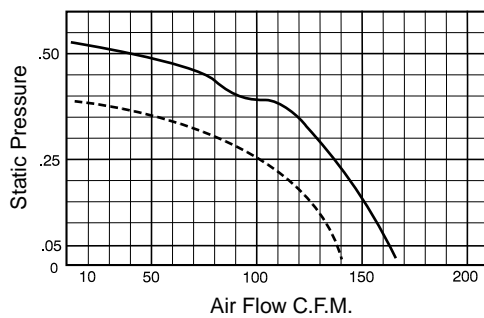

KP350A

KP529A

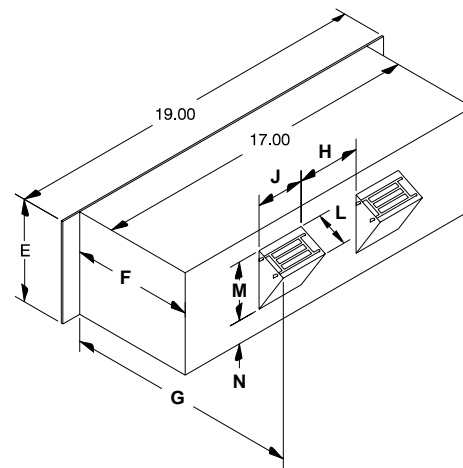
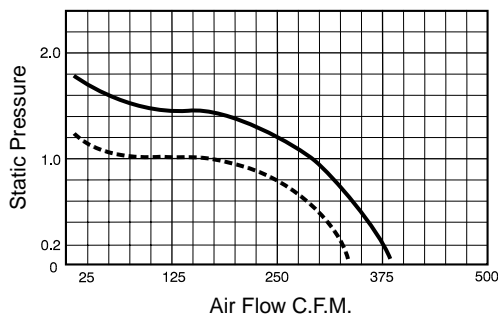

**KP350A
&
KP729A**

KP729A

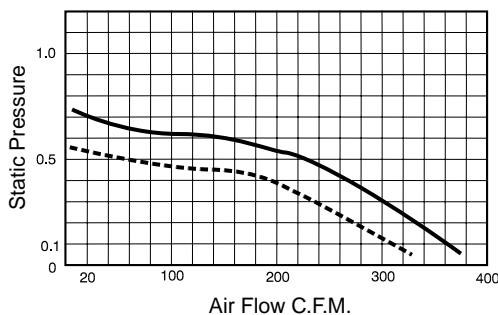

Part Number	Free Flow Air Delivery (CFM)	RPM Nominal	Ambient Temp.		Panel Height		Dimensions (Inches)						
			Min. °F	Max. °F	E	Units	F	G	H	J	L	M	N
KP350A	150	1500	-20	250	3.50	2	8.75	10.50	-	7.50	2.25	2.25	-
KP529A	300	3000	-20	250	5.25	3	6.25	7.69	4.50	4.50	1.88	3.00	1.19
KP729A	470	3250	-20	250	7.00	4	8.25	10.25	4.63	4.75	2.50	4.00	1.44

Accessories

15 Amp - Vertical Rack Mount Outlet Strips

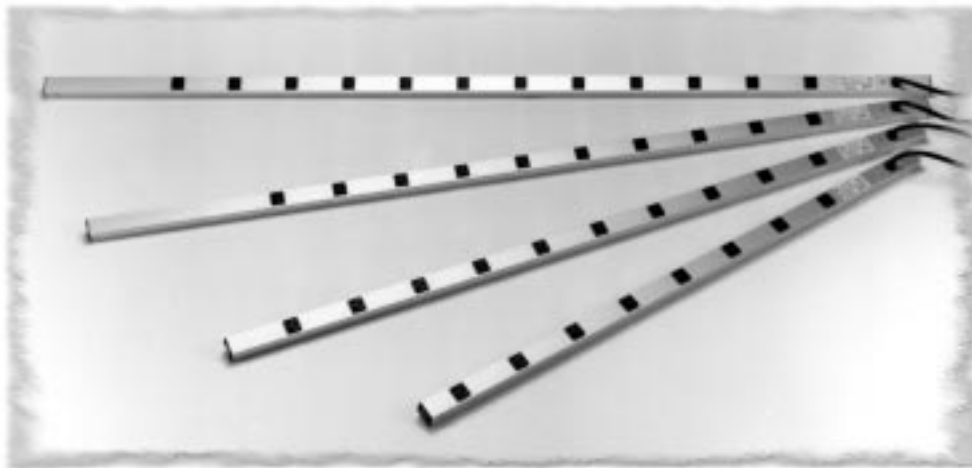

- ~ Designed for power distribution for equipment racks – also handy for work benches
- ~ Rugged extruded aluminum case with 1 5/8" x 1 3/8" profile
- ~ Receptacles are 1" square and are equally spaced over the length of the power strip
- ~ Heavy-duty 14 gauge wire power cord – 14/3 SJTW for extreme temperature ranges
- ~ Integral molded plug available in straight blade (Nema 5-15P) or twist-lock (Nema L5-15P) configuration
- ~ Available with surge protection, on/off switch or red pilot light to indicate power on (see tables)
- ~ Includes 15A, 125VAC circuit breaker to prevent accidental line overload
- ~ Includes hardware for mounting to rack Amhal struts or relay rack sides
- ~ Electrical rating 120VAC/15A
- ~ For additional hardware kit, order part number **1585CLIP**
- ~ **NOTE:** To properly use in racks, allow sufficient depth **BEHIND** the rear panel rails for vertical mounting to amhal struts
- ~ CSA certified
- ~ UL listed (pending on the surge models)

15 Amp Vertical Rack Mount Power Strips With Surge Protection

Part No.	Outlets	On-Off Switch	Pilot Light	Cord Length	Plug Type	Length	Electrical Rating	Shipping Weight
1585H8A1S	8	Yes	-	6'	Straight	48"	120VAC/15A	3.5 lbs
1585H8B1S	8	Yes	-	15'	Straight	48"	120VAC/15A	3.5 lbs
1585H10A1S	10	Yes	-	6'	Straight	48"	120VAC/15A	3.5 lbs
1585H10B1S	10	Yes	-	15'	Straight	48"	120VAC/15A	3.5 lbs
1585H15A1S	15	Yes	-	6'	Straight	48"	120VAC/15A	3.7 lbs
1585H15B1S	15	Yes	-	15'	Straight	48"	120VAC/15A	3.7 lbs
1587H11A1S	11	Yes	-	6'	Straight	70"	120VAC/15A	3.5 lbs
1587H11B1S	11	Yes	-	15'	Straight	70"	120VAC/15A	3.5 lbs
1587H19A1S	19	Yes	-	6'	Straight	70"	120VAC/15A	4.8 lbs
1587H19B1S	19	Yes	-	15'	Straight	70"	120VAC/15A	4.8 lbs
1588H12A1S	12	Yes	-	6'	Straight	77"	120VAC/15A	3.5 lbs
1588H12B1S	12	Yes	-	15'	Straight	77"	120VAC/15A	3.5 lbs
1585T8A1S	8	-	Yes	6'	Straight	48"	120VAC/15A	3.5 lbs
1585T8B1S	8	-	Yes	15'	Straight	48"	120VAC/15A	3.5 lbs
1585T10A1S	10	-	Yes	6'	Straight	48"	120VAC/15A	3.5 lbs
1585T10B1S	10	-	Yes	15'	Straight	48"	120VAC/15A	3.5 lbs
1585T15A1S	15	-	Yes	6'	Straight	48"	120VAC/15A	3.7 lbs
1585T15B1S	15	-	Yes	15'	Straight	48"	120VAC/15A	3.7 lbs
1587T11A1S	11	-	Yes	6'	Straight	70"	120VAC/15A	3.5 lbs
1587T11B1S	11	-	Yes	15'	Straight	70"	120VAC/15A	3.5 lbs
1587T19A1S	19	-	Yes	6'	Straight	70"	120VAC/15A	4.8 lbs
1587T19B1S	19	-	Yes	15'	Straight	70"	120VAC/15A	4.8 lbs
1588T12A1S	12	-	Yes	6'	Straight	77"	120VAC/15A	3.5 lbs
1588T12B1S	12	-	Yes	15'	Straight	77"	120VAC/15A	3.5 lbs



15 Amp - Vertical Rack Mount Outlet Strips

15 Amp Vertical Rack Mount Power Strips - With On/Off Switch

Part No.	Outlets	Cord Length	Plug Type	Length	Shipping Weight
15851H6A1	6	6'	Straight	18"	2.5 lbs
15851H6B1	6	15'	Straight	18"	2.5 lbs
15851H6C1	6	6'	Twist Lock	18"	2.5 lbs
15851H6D1	6	15'	Twist Lock	18"	2.5 lbs
15852H6A1	6	6'	Straight	24"	2.5 lbs
15852H6B1	6	15'	Straight	24"	2.5 lbs
15852H6C1	6	6'	Twist Lock	24"	2.5 lbs
15852H6D1	6	15'	Twist Lock	24"	2.5 lbs
15852H8A1	8	6'	Straight	24"	2.5 lbs
15852H8B1	8	15'	Straight	24"	2.5 lbs
15852H8C1	8	6'	Twist Lock	24"	2.5 lbs
15852H8D1	8	15'	Twist Lock	24"	3.5 lbs
15853H6A1	6	6'	Straight	36"	3.0 lbs
15853H6B1	6	15'	Straight	36"	3.0 lbs
15853H6C1	6	6'	Twist Lock	36"	3.0 lbs
15853H6D1	6	15'	Twist Lock	36"	3.0 lbs
15854H7A1	7	6'	Straight	42"	3.5 lbs
15854H7B1	7	15'	Straight	42"	3.5 lbs
15854H7C1	7	6'	Twist Lock	42"	3.5 lbs
15854H7D1	7	15'	Twist Lock	42"	3.5 lbs
1585H8A1	8	6'	Straight	48"	3.5 lbs
1585H8B1	8	15'	Straight	48"	3.5 lbs
1585H8C1	8	6'	Twist Lock	48"	3.5 lbs
1585H8D1	8	15'	Twist Lock	48"	3.5 lbs
1585H10A1	10	6'	Straight	48"	3.5 lbs
1585H10B1	10	15'	Straight	48"	3.5 lbs
1585H10C1	10	6'	Twist Lock	48"	3.5 lbs
1585H10D1	10	15'	Twist Lock	48"	3.5 lbs
1585H11A1	11	6'	Straight	48"	3.5 lbs
1585H11B1	11	15'	Straight	48"	3.5 lbs
1585H11C1	11	6'	Twist Lock	48"	3.5 lbs
1585H11D1	11	15'	Twist Lock	48"	3.5 lbs
1585H15A1	15	6'	Straight	48"	3.7 lbs
1585H15B1	15	15'	Straight	48"	3.7 lbs
1585H15C1	15	6'	Twist Lock	48"	3.7 lbs
1585H15D1	15	15'	Twist Lock	48"	3.7 lbs

Part No.	Outlets	Cord Length	Plug Type	Length	Shipping Weight
1585H16A1	16	6'	Straight	48"	3.7 lbs
1585H16B1	16	15'	Straight	48"	3.7 lbs
1585H16C1	16	6'	Twist Lock	48"	3.7 lbs
1585H16D1	16	15'	Twist Lock	48"	3.7 lbs
1586H10A1	10	6'	Straight	60"	3.7 lbs
1586H10B1	10	15'	Straight	60"	3.7 lbs
1586H10C1	10	6'	Twist Lock	60"	3.7 lbs
1586H10D1	10	15'	Twist Lock	60"	3.5 lbs
1586H12A1	12	6'	Straight	60"	3.7 lbs
1586H12B1	12	15'	Straight	60"	3.7 lbs
1586H12C1	12	6'	Twist Lock	60"	3.7 lbs
1586H12D1	12	15'	Twist Lock	60"	4.8 lbs
1587H10A1	10	6'	Straight	70"	4.2 lbs
1587H10B1	10	15'	Straight	70"	4.2 lbs
1587H10C1	10	6'	Twist Lock	70"	4.2 lbs
1587H10D1	10	15'	Twist Lock	70"	4.2 lbs
1587H11A1	11	6'	Straight	70"	4.2 lbs
1587H11B1	11	15'	Straight	70"	4.2 lbs
1587H11C1	11	6'	Twist Lock	70"	4.2 lbs
1587H11D1	11	15'	Twist Lock	70"	4.2 lbs
1587H12A1	12	6'	Straight	70"	4.2 lbs
1587H12B1	12	15'	Straight	70"	4.2 lbs
1587H12C1	12	6'	Twist Lock	70"	4.2 lbs
1587H12D1	12	15'	Twist Lock	70"	4.2 lbs
1587H19A1	19	6'	Straight	70"	4.8 lbs
1587H19B1	19	15'	Straight	70"	4.8 lbs
1587H19C1	19	6'	Twist Lock	70"	4.8 lbs
1587H19D1	19	15'	Twist Lock	70"	4.8 lbs
1587H24A1	24	6'	Straight	70"	4.8 lbs
1587H24B1	24	15'	Straight	70"	4.8 lbs
1587H24C1	24	6'	Twist Lock	70"	4.8 lbs
1587H24D1	24	15'	Twist Lock	70"	4.8 lbs
1588H12A1	12	6'	Straight	77"	4.8 lbs
1588H12B1	12	15'	Straight	77"	4.8 lbs
1588H12C1	12	6'	Twist Lock	77"	4.8 lbs
1588H12D1	12	15'	Twist Lock	77"	4.8 lbs

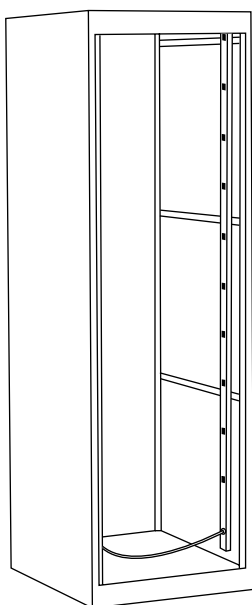

Hardware Kit: part number **1585CLIP** (included)



Accessories



Hammond Manufacturing Co. Ltd.
394 Edinburgh Rd. North
Guelph, Ontario N1H 1E5 CANADA
© Phone: 519-822-2960 Fax: 519-822-0715



Hammond Manufacturing Co. Inc.
256 Sonwil Dr.
Cheektowaga, NY 14225 USA
Phone: 716-651-0086 Fax: 716-651-0726

15 Amp - Vertical Rack Mount Outlet Strips

15 Amp Vertical Rack Mount Power Strips - With Pilot Light

Part No.	Outlets	Cord Length	Plug Type	Length	Shipping Weight
15851T6A1	6	6'	Straight	18"	2.5 lbs
15851T6B1	6	15'	Straight	18"	2.5 lbs
15851T6C1	6	6'	Twist Lock	18"	2.5 lbs
15851T6D1	6	15'	Twist Lock	18"	2.5 lbs
15852T6A1	6	6'	Straight	24"	2.5 lbs
15852T6B1	6	15'	Straight	24"	2.5 lbs
15852T6C1	6	6'	Twist Lock	24"	2.5 lbs
15852T6D1	6	15'	Twist Lock	24"	2.5 lbs
15852T8A1	8	6'	Straight	24"	2.5 lbs
15852T8B1	8	15'	Straight	24"	2.5 lbs
15852T8C1	8	6'	Twist Lock	24"	2.5 lbs
15852T8D1	8	15'	Twist Lock	24"	3.5 lbs
15853T6A1	6	6'	Straight	36"	3.0 lbs
15853T6B1	6	15'	Straight	36"	3.0 lbs
15853T6C1	6	6'	Twist Lock	36"	3.0 lbs
15853T6D1	6	15'	Twist Lock	36"	3.0 lbs
15854T7A1	7	6'	Straight	42"	3.5 lbs
15854T7B1	7	15'	Straight	42"	3.5 lbs
15854T7C1	7	6'	Twist Lock	42"	3.5 lbs
15854T7D1	7	15'	Twist Lock	42"	3.5 lbs
1585T8A1	8	6'	Straight	48"	3.5 lbs
1585T8B1	8	15'	Straight	48"	3.5 lbs
1585T8C1	8	6'	Twist Lock	48"	3.5 lbs
1585T8D1	8	15'	Twist Lock	48"	3.5 lbs
1585T10A1	10	6'	Straight	48"	3.5 lbs
1585T10B1	10	15'	Straight	48"	3.5 lbs
1585T10C1	10	6'	Twist Lock	48"	3.5 lbs
1585T10D1	10	15'	Twist Lock	48"	3.5 lbs
1585T11A1	11	6'	Straight	48"	3.5 lbs
1585T11B1	11	15'	Straight	48"	3.5 lbs
1585T11C1	11	6'	Twist Lock	48"	3.5 lbs
1585T11D1	11	15'	Twist Lock	48"	3.5 lbs
1585T15A1	15	6'	Straight	48"	3.7 lbs
1585T15B1	15	15'	Straight	48"	3.7 lbs
1585T15C1	15	6'	Twist Lock	48"	3.7 lbs
1585T15D1	15	15'	Twist Lock	48"	3.7 lbs

Part No.	Outlets	Cord Length	Plug Type	Length	Shipping Weight
1585T16A1	16	6'	Straight	48"	3.7 lbs
1585T16B1	16	15'	Straight	48"	3.7 lbs
1585T16C1	16	6'	Twist Lock	48"	3.7 lbs
1585T16D1	16	15'	Twist Lock	48"	3.7 lbs
1586T10A1	10	6'	Straight	60"	3.7 lbs
1586T10B1	10	15'	Straight	60"	3.7 lbs
1586T10C1	10	6'	Twist Lock	60"	3.7 lbs
1586T10D1	10	15'	Twist Lock	60"	3.5 lbs
1586T12A1	12	6'	Straight	60"	3.7 lbs
1586T12B1	12	15'	Straight	60"	3.7 lbs
1586T12C1	12	6'	Twist Lock	60"	3.7 lbs
1586T12D1	12	15'	Twist Lock	60"	4.2 lbs
1587T10A1	10	6'	Straight	70"	4.2 lbs
1587T10B1	10	15'	Straight	70"	4.2 lbs
1587T10C1	10	6'	Twist Lock	70"	4.2 lbs
1587T10D1	10	15'	Twist Lock	70"	4.2 lbs
1587T11A1	11	6'	Straight	70"	4.2 lbs
1587T11B1	11	15'	Straight	70"	4.2 lbs
1587T11C1	11	6'	Twist Lock	70"	4.2 lbs
1587T11D1	11	15'	Twist Lock	70"	4.2 lbs
1587T12A1	12	6'	Straight	70"	4.2 lbs
1587T12B1	12	15'	Straight	70"	4.2 lbs
1587T12C1	12	6'	Twist Lock	70"	4.2 lbs
1587T12D1	12	15'	Twist Lock	70"	4.2 lbs
1587T19A1	19	6'	Straight	70"	4.8 lbs
1587T19B1	19	15'	Straight	70"	4.8 lbs
1587T19C1	19	6'	Twist Lock	70"	4.8 lbs
1587T19D1	19	15'	Twist Lock	70"	4.8 lbs
1587T24A1	24	6'	Straight	70"	4.8 lbs
1587T24B1	24	15'	Straight	70"	4.8 lbs
1587T24C1	24	6'	Twist Lock	70"	4.8 lbs
1587T24D1	24	15'	Twist Lock	70"	4.8 lbs
1588T12A1	12	6'	Straight	77"	4.8 lbs
1588T12B1	12	15'	Straight	77"	4.8 lbs
1588T12C1	12	6'	Twist Lock	77"	4.8 lbs
1588T12D1	12	15'	Twist Lock	77"	4.8 lbs

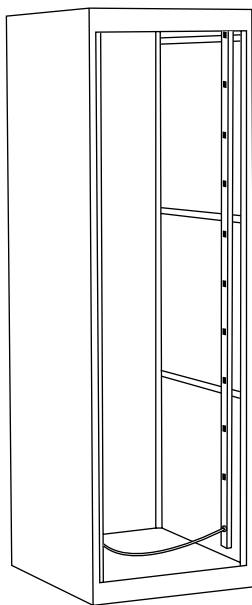

Hardware Kit: part number **1585CLIP** (included)



Accessories

20 Amp - Vertical Rack Mount Outlet Strips

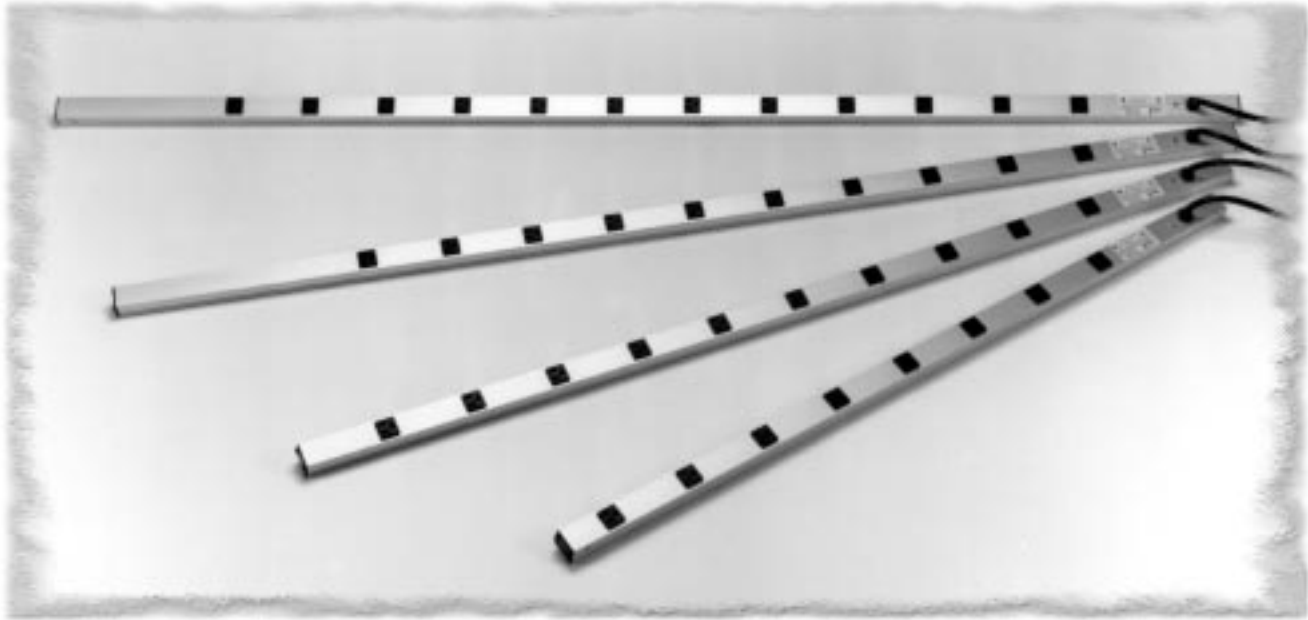

- ~ Designed for power distribution for equipment racks – also handy for work benches
- ~ Designed for applications with heavy current draw
- ~ Rugged extruded aluminum case with 1 5/8" x 1 3/8" profile
- ~ Receptacles are 1" square and are equally spaced over the length of the power strip
- ~ Integral molded plug available in straight blade (Nema 5-20P) or twist-lock (Nema L5-20P) configurations (see table)
- ~ Available with on/off switch or red pilot light to indicate power on (see table)
- ~ Electrical rating of 120VAC/20A
- ~ 20A outlets with 20A circuit breaker, 12 gauge wire - 12/3 SJTW 20A heavy duty power cord for extreme temperature ranges
- ~ Includes hardware for mounting to rack Amhal struts or relay rack sides
- ~ For additional hardware kit, order part number **1585CLIP**
- ~ **NOTE:** To properly use in racks, allow sufficient depth **BEHIND** the rear panel rails for vertical mounting to amhal struts
- ~ CSA certified
- ~ UL listed

Hardware Kit: part number **1585CLIP** (included)

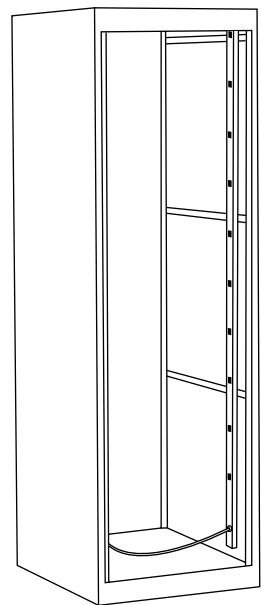

Accessories



Hammond Manufacturing Co. Ltd.
394 Edinburgh Rd. North
Guelph, Ontario N1H 1E5 CANADA
© Phone: 519-822-2960 Fax: 519-822-0715



Hammond Manufacturing Co. Inc.
256 Sonwil Dr.
Cheektowaga, NY 14225 USA
Phone: 716-651-0086 Fax: 716-651-0726

20 Amp - Vertical Rack Mount Outlet Strips

20 Amp Vertical Rack Mount Power Strips - With On/Off Switch

20 Amp Vertical Rack Mount Power Strips - With Pilot Light

Part No.	Outlets	Cord Length	Plug Type	Length	Shipping Weight
1589H18C1	6	6'	Twist Lock	18"	2.7 lbs
1589H18D1	6	15'	Twist Lock	18"	2.7 lbs
1589H18F1	6	6'	Straight	18"	2.5 lbs
1589H18G1	6	15'	Straight	18"	3.0 lbs
1589H24C1	8	6'	Twist Lock	24"	2.7 lbs
1589H24D1	8	15'	Twist Lock	24"	2.7 lbs
1589H24F1	8	6'	Straight	24"	2.5 lbs
1589H24G1	8	15'	Straight	24"	3.0 lbs
1589H36C1	6	6'	Twist Lock	36"	3.2 lbs
1589H36D1	6	15'	Twist Lock	36"	3.2 lbs
1589H36F1	6	6'	Straight	36"	3.0 lbs
1589H36G1	6	15'	Straight	36"	3.5 lbs
1589H42C1	7	6'	Twist Lock	42"	3.7 lbs
1589H42D1	7	15'	Twist Lock	42"	3.7 lbs
1589H42F1	7	6'	Straight	42"	3.5 lbs
1589H42G1	7	15'	Straight	42"	4.0 lbs
1589H48C1	8	6'	Twist Lock	48"	3.7 lbs
1589H48D1	8	15'	Twist Lock	48"	3.7 lbs
1589H48F1	8	6'	Straight	48"	3.5 lbs
1589H48G1	8	15'	Straight	48"	4.0 lbs
1589H48C116	16	6'	Twist Lock	48"	3.9 lbs
1589H48D116	16	15'	Twist Lock	48"	3.9 lbs
1589H48F116	16	6'	Straight	48"	3.7 lbs
1589H48G116	16	15'	Straight	48"	4.2 lbs
1589H60C1	10	6'	Twist Lock	60"	3.7 lbs
1589H60D1	10	15'	Twist Lock	60"	3.7 lbs
1589H60F1	10	6'	Straight	60"	3.5 lbs
1589H60G1	10	15'	Straight	60"	4.0 lbs
1589H70C1	10	6'	Twist Lock	70"	4.2 lbs
1589H70D1	10	15'	Twist Lock	70"	4.2 lbs
1589H70F1	10	6'	Straight	70"	4.0 lbs
1589H70G1	10	15'	Straight	70"	4.5 lbs
1589H70C124	24	6'	Twist Lock	70"	4.4 lbs
1589H70D124	24	15'	Twist Lock	70"	4.4 lbs
1589H70F124	24	6'	Straight	70"	4.2 lbs
1589H70G124	24	15'	Straight	70"	4.7 lbs
1589H77C1	12	6'	Twist Lock	77"	4.8 lbs
1589H77D1	12	15'	Twist Lock	77"	4.8 lbs
1589H77F1	12	6'	Straight	77"	4.6 lbs
1589H77G1	12	15'	Straight	77"	5.1 lbs

Part No.	Outlets	Cord Length	Plug Type	Length	Shipping Weight
1589T18C1	6	6'	Twist Lock	18"	2.7 lbs
1589T18D1	6	15'	Twist Lock	18"	2.7 lbs
1589T18F1	6	6'	Straight	18"	2.5 lbs
1589T18G1	6	15'	Straight	18"	3.0 lbs
1589T24C1	8	6'	Twist Lock	24"	2.7 lbs
1589T24D1	8	15'	Twist Lock	24"	2.7 lbs
1589T24F1	8	6'	Straight	24"	2.5 lbs
1589T24G1	8	15'	Straight	24"	3.0 lbs
1589T36C1	6	6'	Twist Lock	36"	3.2 lbs
1589T36D1	6	15'	Twist Lock	36"	3.2 lbs
1589T36F1	6	6'	Straight	36"	3.0 lbs
1589T36G1	6	15'	Straight	36"	3.5 lbs
1589T42C1	7	6'	Twist Lock	42"	3.7 lbs
1589T42D1	7	15'	Twist Lock	42"	3.7 lbs
1589T42F1	7	6'	Straight	42"	3.5 lbs
1589T42G1	7	15'	Straight	42"	4.0 lbs
1589T48C1	8	6'	Twist Lock	48"	3.7 lbs
1589T48D1	8	15'	Twist Lock	48"	3.7 lbs
1589T48F1	8	6'	Straight	48"	3.5 lbs
1589T48G1	8	15'	Straight	48"	4.0 lbs
1589T48C116	16	6'	Twist Lock	48"	3.9 lbs
1589T48D116	16	15'	Twist Lock	48"	3.9 lbs
1589T48F116	16	6'	Straight	48"	3.7 lbs
1589T48G116	16	15'	Straight	48"	4.2 lbs
1589T60C1	10	6'	Twist Lock	60"	3.7 lbs
1589T60D1	10	15'	Twist Lock	60"	3.7 lbs
1589T60F1	10	6'	Straight	60"	3.5 lbs
1589T60G1	10	15'	Straight	60"	4.0 lbs
1589T70C1	10	6'	Twist Lock	70"	4.2 lbs
1589T70D1	10	15'	Twist Lock	70"	4.2 lbs
1589T70F1	10	6'	Straight	70"	4.0 lbs
1589T70G1	10	15'	Straight	70"	4.5 lbs
1589T70C124	24	6'	Twist Lock	70"	4.4 lbs
1589T70D124	24	15'	Twist Lock	70"	4.4 lbs
1589T70F124	24	6'	Straight	70"	4.2 lbs
1589T70G124	24	15'	Straight	70"	4.7 lbs
1589T77C1	12	6'	Twist Lock	77"	4.8 lbs
1589T77D1	12	15'	Twist Lock	77"	4.8 lbs
1589T77F1	12	6'	Straight	77"	4.6 lbs
1589T77G1	12	15'	Straight	77"	5.1 lbs

15 Amp - Rack Mount Power Panels



- ~ Designed for power distribution from front and rear of unit.
- ~ Tough steel case painted in black powder coat finish.
- ~ Heavy-duty 14 gauge wire power cord – 14/3 SJTW for extreme temperature ranges.
- ~ Integral molded plug available in straight blade (Nema 5-15P) or twist-lock (Nema L5-15P) configurations.
- ~ Available with lighted on/off switch or red pilot light to indicate power on.
- ~ Includes 15A, 125VAC circuit breaker to prevent accidental line overload.
- ~ CSA certified.
- ~ UL recognized - under the component program of UL.



15 Amp Rack Mount (Front & Rear Receptacles)

Part No.	Total Outlets	Front Outlets	Rear Outlets	On-Off Switch	Pilot Light	Cord Length	Cord Type	Dimensions (Inches) L x W x H	Electrical Rating	Shipping Weight
1583H6A1BKX	6	2	4	Yes	-	6'	Straight	19 x 3 x 1.75	120VAC/15A	4 lbs
1583H6B1BKX	6	2	4	Yes	-	15'	Straight	19 x 3 x 1.75	120VAC/15A	4 lbs
1583H6C1BKX	6	2	4	Yes	-	6'	Twist Lock	19 x 3 x 1.75	120VAC/15A	4 lbs
1583H6D1BKX	6	2	4	Yes	-	15'	Twist Lock	19 x 3 x 1.75	120VAC/15A	4 lbs
1583T6A1BKX	6	2	4	-	Yes	6'	Straight	19 x 3 x 1.75	120VAC/15A	4 lbs
1583T6B1BKX	6	2	4	-	Yes	15'	Straight	19 x 3 x 1.75	120VAC/15A	4 lbs
1583T6C1BKX	6	2	4	-	Yes	6'	Twist Lock	19 x 3 x 1.75	120VAC/15A	4 lbs
1583T6D1BKX	6	2	4	-	Yes	15'	Twist Lock	19 x 3 x 1.75	120VAC/15A	4 lbs
1583H12A1BKX	12	6	6	Yes	-	6'	Straight	19 x 3 x 1.75	120VAC/15A	4 lbs
1583H12B1BKX	12	6	6	Yes	-	15'	Straight	19 x 3 x 1.75	120VAC/15A	4 lbs
1583H12C1BKX	12	6	6	Yes	-	6'	Twist Lock	19 x 3 x 1.75	120VAC/15A	4 lbs
1583H12D1BKX	12	6	6	Yes	-	15'	Twist Lock	19 x 3 x 1.75	120VAC/15A	4 lbs
1583T12A1BKX	12	6	6	-	Yes	6'	Straight	19 x 3 x 1.75	120VAC/15A	4 lbs
1583T12B1BKX	12	6	6	-	Yes	15'	Straight	19 x 3 x 1.75	120VAC/15A	4 lbs
1583T12C1BKX	12	6	6	-	Yes	6'	Twist Lock	19 x 3 x 1.75	120VAC/15A	4 lbs
1583T12D1BKX	12	6	6	-	Yes	15'	Twist Lock	19 x 3 x 1.75	120VAC/15A	4 lbs

Accessories

15 Amp - Rack Mount Power Panels



- ~ Designed for power distribution from front of unit.
- ~ Tough steel case available in ASA 61 grey or black powder coat finish.
- ~ Heavy-duty 14 gauge wire power cord – 14/3 SJTW for extreme temperature ranges.
- ~ Integral molded plug available in straight blade (Nema 5-15P) or twist-lock (Nema L5-15P) configurations.
- ~ 6 outlet models include 2 outlets with extra space for clearance of most plug in transformers.
- ~ Available with lighted on/off switch or red pilot light to indicate power on.
- ~ Includes 15A, 125VAC circuit breaker to prevent accidental line overload.
- ~ Panel dimensions are 1.75" high (1U) and 19" rack width.
- ~ CSA certified.
- ~ UL recognized - under the component program of UL.
- ~ For surge protected panels incorporating our ZT206 module:
 - 8,000 Amp rated MOV's, two ferrite rod inductors & filter capacitor provide surge suppression and EMI/RFI noise protection
 - Maximum 24,000 Amps transient current
 - 330V UL 1449 rating
 - Response time of less than 1 nanosecond
 - Protection in all 3 AC modes
 - Voltage suppression at the outlet guards against transients from equipment on the power bar

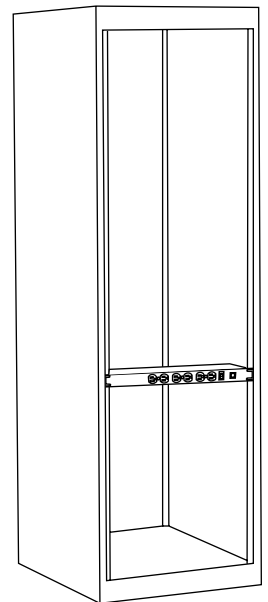

15 Amp - Rack Mount Power Panels

15 Amp Rack Mount Power Panels (Front Receptacles)

Part No.	Outlets	On-Off Switch	Pilot Light	Cord Length	Plug Type	Color	Dimensions (Inches) L x W x H	Electrical Rating	Shipping Weight
1582H6A1	6	Yes	-	6'	Straight	Grey	19 x 3 x 1.75	120VAC / 15A	4 lbs
1582H6A1BK	6	Yes	-	6'	Straight	Black	19 x 3 x 1.75	120VAC / 15A	4 lbs
1582H6B1	6	Yes	-	15'	Straight	Grey	19 x 3 x 1.75	120VAC / 15A	4 lbs
1582H6B1BK	6	Yes	-	15'	Straight	Black	19 x 3 x 1.75	120VAC / 15A	4 lbs
1582H6C1	6	Yes	-	6'	Twist Lock	Grey	19 x 3 x 1.75	120VAC / 15A	4 lbs
1582H6C1BK	6	Yes	-	6'	Twist Lock	Black	19 x 3 x 1.75	120VAC / 15A	4 lbs
1582H6D1	6	Yes	-	15'	Twist Lock	Grey	19 x 3 x 1.75	120VAC / 15A	4 lbs.
1582H6D1BK	6	Yes	-	15'	Twist Lock	Black	19 x 3 x 1.75	120VAC / 15A	4 lbs.
1582H8A1	8	Yes	-	6'	Straight	Grey	19 x 3 x 1.75	120VAC / 15A	4 lbs
1582H8A1BK	8	Yes	-	6'	Straight	Black	19 x 3 x 1.75	120VAC / 15A	4 lbs
1582H8B1	8	Yes	-	15'	Straight	Grey	19 x 3 x 1.75	120VAC / 15A	4 lbs
1582H8B1BK	8	Yes	-	15'	Straight	Black	19 x 3 x 1.75	120VAC / 15A	4 lbs
1582H8C1	8	Yes	-	6'	Twist Lock	Grey	19 x 3 x 1.75	120VAC / 15A	4 lbs
1582H8C1BK	8	Yes	-	6'	Twist Lock	Black	19 x 3 x 1.75	120VAC / 15A	4 lbs
1582H8D1	8	Yes	-	15'	Twist Lock	Grey	19 x 3 x 1.75	120VAC / 15A	4 lbs.
1582H8D1BK	8	Yes	-	15'	Twist Lock	Black	19 x 3 x 1.75	120VAC / 15A	4 lbs.
1582T6A1	6	-	Yes	6'	Straight	Grey	19 x 3 x 1.75	120VAC / 15A	4 lbs
1582T6A1BK	6	-	Yes	6'	Straight	Black	19 x 3 x 1.75	120VAC / 15A	4 lbs
1582T6B1	6	-	Yes	15'	Straight	Grey	19 x 3 x 1.75	120VAC / 15A	4 lbs
1582T6B1BK	6	-	Yes	15'	Straight	Black	19 x 3 x 1.75	120VAC / 15A	4 lbs
1582T6C1	6	-	Yes	6'	Twist Lock	Grey	19 x 3 x 1.75	120VAC / 15A	4 lbs
1582T6C1BK	6	-	Yes	6'	Twist Lock	Black	19 x 3 x 1.75	120VAC / 15A	4 lbs
1582T6D1	6	-	Yes	15'	Twist Lock	Grey	19 x 3 x 1.75	120VAC / 15A	4 lbs.
1582T6D1BK	6	-	Yes	15'	Twist Lock	Black	19 x 3 x 1.75	120VAC / 15A	4 lbs.
1582T8A1	8	-	Yes	6'	Straight	Grey	19 x 3 x 1.75	120VAC / 15A	4 lbs
1582T8A1BK	8	-	Yes	6'	Straight	Black	19 x 3 x 1.75	120VAC / 15A	4 lbs
1582T8B1	8	-	Yes	15'	Straight	Grey	19 x 3 x 1.75	120VAC / 15A	4 lbs
1582T8B1BK	8	-	Yes	15'	Straight	Black	19 x 3 x 1.75	120VAC / 15A	4 lbs
1582T8C1	8	-	Yes	6'	Twist Lock	Grey	19 x 3 x 1.75	120VAC / 15A	4 lbs
1582T8C1BK	8	-	Yes	6'	Twist Lock	Black	19 x 3 x 1.75	120VAC / 15A	4 lbs
1582T8D1	8	-	Yes	15'	Twist Lock	Grey	19 x 3 x 1.75	120VAC / 15A	4 lbs
1582T8D1BK	8	-	Yes	15'	Twist Lock	Black	19 x 3 x 1.75	120VAC / 15A	4 lbs

15 Amp Rack Mount Power Panels (Front Receptacles) With Surge Protection

Part No.	Outlets	On-Off Switch	Pilot Light	Cord Length	Plug Type	Color	Dimensions (Inches) L x W x H	Electrical Rating	Shipping Weight
1582H6A1S	6	Yes	-	6'	Straight	Grey	19 x 3 x 1.75	120VAC / 15A	4 lbs
1582H6A1SBK	6	Yes	-	6'	Straight	Black	19 x 3 x 1.75	120VAC / 15A	4 lbs
1582H6B1S	6	Yes	-	15'	Straight	Grey	19 x 3 x 1.75	120VAC / 15A	4 lbs
1582H6B1SBK	6	Yes	-	15'	Straight	Black	19 x 3 x 1.75	120VAC / 15A	4 lbs
1582H6C1S	6	Yes	-	6'	Twist Lock	Grey	19 x 3 x 1.75	120VAC / 15A	4 lbs
1582H6C1SBK	6	Yes	-	6'	Twist Lock	Black	19 x 3 x 1.75	120VAC / 15A	4 lbs
1582H6D1S	6	Yes	-	15'	Twist Lock	Grey	19 x 3 x 1.75	120VAC / 15A	4 lbs
1582H6D1SBK	6	Yes	-	15'	Twist Lock	Black	19 x 3 x 1.75	120VAC / 15A	4 lbs



15 Amp - Rack Mount Power Panels

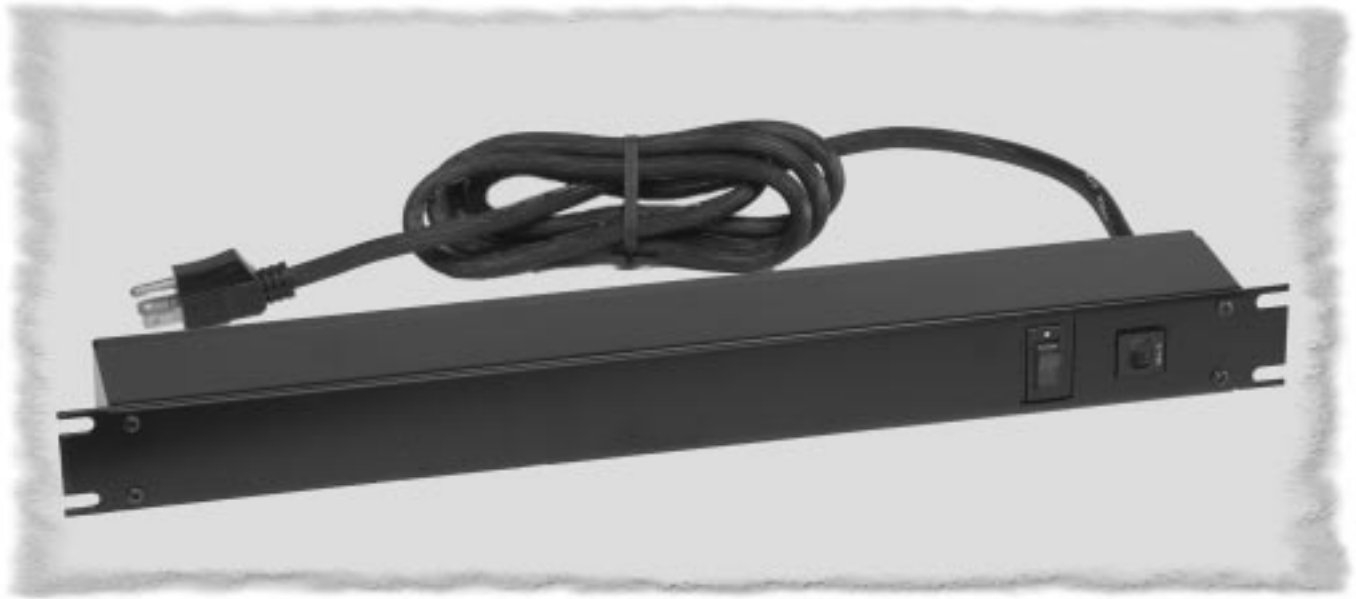

- ~ Designed for power distribution from rear of unit.
- ~ Tough steel case available in ASA 61 grey or black powder coat finish.
- ~ Heavy-duty 14 gauge wire power cord – 14/3 SJTW for extreme temperature ranges.
- ~ Integral molded plug available in straight blade (Nema 5-15P) or twist-lock (Nema L5-15P) configurations.
- ~ 6 outlet models include 2 outlets with extra space for clearance of most plug in transformers.
- ~ Available with lighted on/off switch or red pilot light to indicate power on.
- ~ Includes 15A, 125VAC circuit breaker to prevent accidental line overload.
- ~ Panel dimensions are 1.75" high (1U) and 19" width.
- ~ CSA certified.
- ~ UL recognized - under the component program of UL.
- ~ For surge protected panels incorporating our ZT206 module:
 - 8,000 Amp rated MOV's, two ferrite rod inductors & filter capacitor provide surge suppression and EMI/RFI noise protection
 - Maximum 24,000 Amps transient current
 - 330V UL 1449 rating
 - Response time of less than 1 nanosecond
 - Protection in all 3 AC modes
 - Voltage suppression at the outlet guards against transients from equipment on the power bar

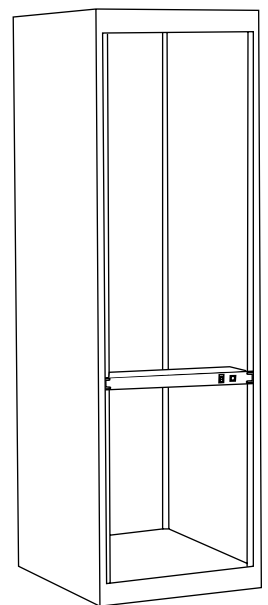

15 Amp - Rack Mount Power Panels

15 Amp Rack Mount Power Panels (Rear Receptacles)

Part No.	Outlets	On-Off Switch	Pilot Light	Cord Length	Plug Type	Color	Dimensions (Inches) L x W x H	Electrical Rating	Shipping Weight
1583H6A1	6	Yes	-	6'	Straight	Grey	19 x 3 x 1.75	120VAC /15A	4 lbs
1583H6A1BK	6	Yes	-	6'	Straight	Black	19 x 3 x 1.75	120VAC /15A	4 lbs
1583H6B1	6	Yes	-	15'	Straight	Grey	19 x 3 x 1.75	120VAC /15A	4 lbs
1583H6B1BK	6	Yes	-	15'	Straight	Black	19 x 3 x 1.75	120VAC /15A	4 lbs
1583H6C1	6	Yes	-	6'	Twist Lock	Grey	19 x 3 x 1.75	120VAC /15A	4 lbs
1583H6C1BK	6	Yes	-	6'	Twist Lock	Black	19 x 3 x 1.75	120VAC /15A	4 lbs
1583H6D1	6	Yes	-	15'	Twist Lock	Grey	19 x 3 x 1.75	120VAC/15A	4 lbs
1583H6D1BK	6	Yes	-	15'	Twist Lock	Black	19 x 3 x 1.75	120 VAC/15A	4 lbs
1583H8A1	8	Yes	-	6'	Straight	Grey	19 x 3 x 1.75	120VAC /15A	4 lbs
1583H8A1BK	8	Yes	-	6'	Straight	Black	19 x 3 x 1.75	120VAC /15A	4 lbs
1583H8B1	8	Yes	-	15'	Straight	Grey	19 x 3 x 1.75	120VAC /15A	4 lbs
1583H8B1BK	8	Yes	-	15'	Straight	Black	19 x 3 x 1.75	120VAC /15A	4 lbs
1583H8C1	8	Yes	-	6'	Twist Lock	Grey	19 x 3 x 1.75	120VAC /15A	4 lbs
1583H8C1BK	8	Yes	-	6'	Twist Lock	Black	19 x 3 x 1.75	120VAC /15A	4 lbs
1583H8D1	8	Yes	-	15'	Twist Lock	Grey	19 x 3 x 1.75	120VAC /15A	4 lbs
1583H8D1BK	8	Yes	-	15'	Twist Lock	Black	19 x 3 x 1.75	120VAC /15A	4 lbs
1583T6A1	6	-	Yes	6'	Straight	Grey	19 x 3 x 1.75	120VAC /15A	4 lbs
1583T6A1BK	6	-	Yes	6'	Straight	Black	19 x 3 x 1.75	120VAC /15A	4 lbs
1583T6B1	6	-	Yes	15'	Straight	Grey	19 x 3 x 1.75	120VAC /15A	4 lbs
1583T6B1BK	6	-	Yes	15'	Straight	Black	19 x 3 x 1.75	120VAC /15A	4 lbs
1583T6C1	6	-	Yes	6'	Twist Lock	Grey	19 x 3 x 1.75	120VAC /15A	4 lbs
1583T6C1BK	6	-	Yes	6'	Twist Lock	Black	19 x 3 x 1.75	120VAC /15A	4 lbs
1583T6D1	6	-	Yes	15'	Twist Lock	Grey	19 x 3 x 1.75	120VAC /15A	4 lbs
1583T6D1BK	6	-	Yes	15'	Twist Lock	Black	19 x 3 x 1.75	120VAC /15A	4 lbs
1583T8A1	8	-	Yes	6'	Straight	Grey	19 x 3 x 1.75	120VAC /15A	4 lbs
1583T8A1BK	8	-	Yes	6'	Straight	Black	19 x 3 x 1.75	120VAC /15A	4 lbs
1583T8B1	8	-	Yes	15'	Straight	Grey	19 x 3 x 1.75	120VAC /15A	4 lbs
1583T8B1BK	8	-	Yes	15'	Straight	Black	19 x 3 x 1.75	120VAC /15A	4 lbs
1583T8C1	8	-	Yes	6'	Twist Lock	Grey	19 x 3 x 1.75	120VAC /15A	4 lbs
1583T8C1BK	8	-	Yes	6'	Twist Lock	Black	19 x 3 x 1.75	120VAC /15A	4 lbs
1583T8D1	8	-	Yes	15'	Twist Lock	Grey	19 x 3 x 1.75	120VAC /15A	4 lbs
1583T8D1BK	8	-	Yes	15'	Twist Lock	Black	19 x 3 x 1.75	120VAC /15A	4 lbs

15 Amp Rack Mount Power Panels (Rear Receptacles) With Surge Protection

Part No.	Outlets	On-Off Switch	Pilot Light	Cord Length	Plug Type	Color	Dimensions (Inches) L x W x H	Electrical Rating	Shipping Weight
1583H6A1S	6	Yes	-	6'	Straight	Grey	19 x 3 x 1.75	120VAC /15A	4 lbs
1583H6A1SBK	6	Yes	-	6'	Straight	Black	19 x 3 x 1.75	120VAC /15A	4 lbs
1583H6B1S	6	Yes	-	15'	Straight	Grey	19 x 3 x 1.75	120VAC /15A	4 lbs
1583H6B1SBK	6	Yes	-	15'	Straight	Black	19 x 3 x 1.75	120VAC /15A	4 lbs
1583H6C1S	6	Yes	-	6'	Twist Lock	Grey	19 x 3 x 1.75	120VAC /15A	4 lbs
1583H6C1SBK	6	Yes	-	6'	Twist Lock	Black	19 x 3 x 1.75	120VAC /15A	4 lbs
1583H6D1S	6	Yes	-	15'	Twist Lock	Grey	19 x 3 x 1.75	120VAC /15A	4 lbs
1583H6D1SBK	6	Yes	-	15'	Twist Lock	Black	19 x 3 x 1.75	120VAC /15A	4 lbs



15 Amp - Rack Mount Power Panels

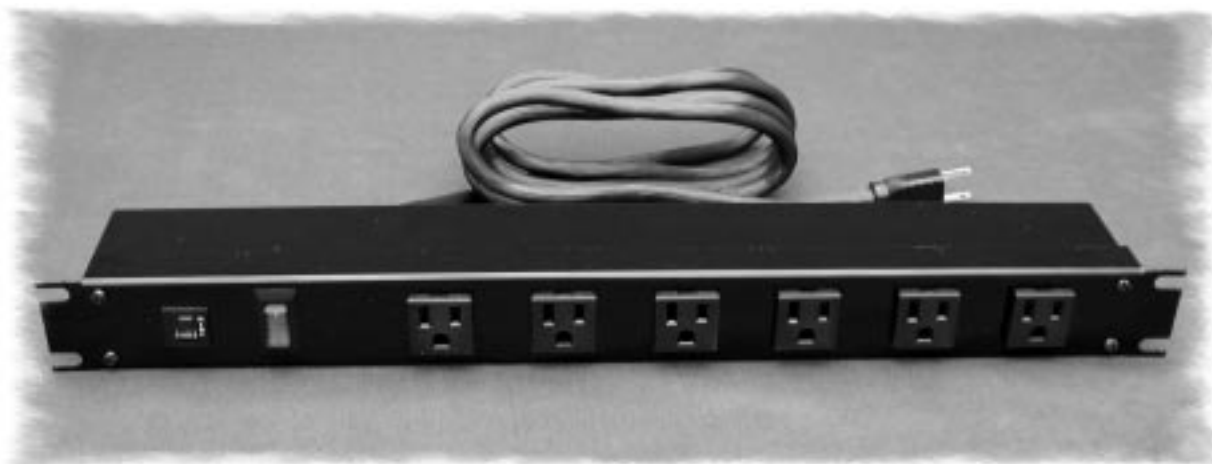

- ~ Receptacles turned 90°
- ~ Designed for power distribution from front or rear of unit.
- ~ Tough steel case available in a black powder coat finish.
- ~ Heavy-duty power cord – 14/3 SJTW for extreme temperature ranges.
- ~ Integral molded straight-blade (NEMA 5-15P) or twist lock (NEMA L5-15P) configuration.
- ~ Available with lighted on/off switch or red pilot light to indicate power on.
- ~ Includes 15A, 125VAC circuit breaker to prevent accidental line overload.
- ~ CSA certified.
- ~ UL recognized - under the component program of UL.



15 Amp Rack Mount Power Panels with 90° Receptacles

Part No.	Outlets	Outlet Location	On-Off Switch	Pilot Light	Plug Type	Cord Length	Dimensions (Inches) LxWxH	Electrical Rating	Shipping Weight
1582H6A1BKRA	6	Front	Yes	-	Straight	6'	19 x 3 x 1.75	120VAC/15A	4 lbs
1582H6B1BKRA	6	Front	Yes	-	Straight	15'	19 x 3 x 1.75	120VAC/15A	4 lbs
1582H6C1BKRA	6	Front	Yes	-	Twist Lock	6'	19 x 3 x 1.75	120VAC/15A	4 lbs
1582H6D1BKRA	6	Front	Yes	-	Twist Lock	15'	19 x 3 x 1.75	120VAC/15A	4 lbs
1582T6A1BKRA	6	Front	-	Yes	Straight	6'	19 x 3 x 1.75	120VAC/15A	4 lbs
1582T6B1BKRA	6	Front	-	Yes	Straight	15'	19 x 3 x 1.75	120VAC/15A	4 lbs
1582T6C1BKRA	6	Front	-	Yes	Twist Lock	6'	19 x 3 x 1.75	120VAC/15A	4 lbs
1582T6D1BKRA	6	Front	-	Yes	Twist Lock	15'	19 x 3 x 1.75	120VAC/15A	4 lbs
1583H6A1BKRA	6	Rear	Yes	-	Straight	6'	19 x 3 x 1.75	120VAC/15A	4 lbs
1583H6B1BKRA	6	Rear	Yes	-	Straight	15'	19 x 3 x 1.75	120VAC/15A	4 lbs
1583H6C1BKRA	6	Rear	Yes	-	Twist Lock	6'	19 x 3 x 1.75	120VAC/15A	4 lbs
1583H6D1BKRA	6	Rear	Yes	-	Twist Lock	15'	19 x 3 x 1.75	120VAC/15A	4 lbs
1583T6A1BKRA	6	Rear	-	Yes	Straight	6'	19 x 3 x 1.75	120VAC/15A	4 lbs
1583T6B1BKRA	6	Rear	-	Yes	Straight	15'	19 x 3 x 1.75	120VAC/15A	4 lbs
1583T6C1BKRA	6	Rear	-	Yes	Twist Lock	6'	19 x 3 x 1.75	120VAC/15A	4 lbs
1583T6D1BKRA	6	Rear	-	Yes	Twist Lock	15'	19 x 3 x 1.75	120VAC/15A	4 lbs

20 Amp - Rack Mount Power Panels



- ~ Designed for power distribution from front or rear of unit.
- ~ Tough steel case painted in black powder coat finish.
- ~ Heavy-duty power cord – 12/3 SJTW for extreme temperature ranges.
- ~ Integral molded plug available in straight blade (Nema 5-20P) or twist-lock (Nema L5-20P) configurations.
- ~ Available with on/off switch or red pilot light to indicate power on.
- ~ Includes 20A, 125VAC circuit breaker to prevent accidental line overload.
- ~ CSA certified.
- ~ UL recognized - under the component program of UL.



20 Amp Rack Mount (Front Receptacles)

Part No.	Outlets	On-Off Switch	Pilot Light	Cord Length	Plug Type	Dimensions (Inches)	Electrical Rating	Shipping Weight
1589H6C1BKRF	6	Yes	-	6'	Twist Lock	19 x 3 x 1.75	120VAC/20A	4.2 lbs
1589H6D1BKRF	6	Yes	-	15'	Twist Lock	19 x 3 x 1.75	120VAC/20A	4.5 lbs
1589H6F1BKRF	6	Yes	-	6'	Straight	19 x 3 x 1.75	120VAC/20A	4.0 lbs
1589H6G1BKRF	6	Yes	-	15'	Straight	19 x 3 x 1.75	120VAC/20A	4.5 lbs
1589T6C1BKRF	6	-	Yes	6'	Twist Lock	19 x 3 x 1.75	120VAC/20A	4.2 lbs
1589T6D1BKRF	6	-	Yes	15'	Twist Lock	19 x 3 x 1.75	120VAC/20A	4.5 lbs
1589T6F1BKRF	6	-	Yes	6'	Straight	19 x 3 x 1.75	120VAC/20A	4.0 lbs
1589T6G1BKRF	6	-	Yes	15'	Straight	19 x 3 x 1.75	120VAC/20A	4.5 lbs

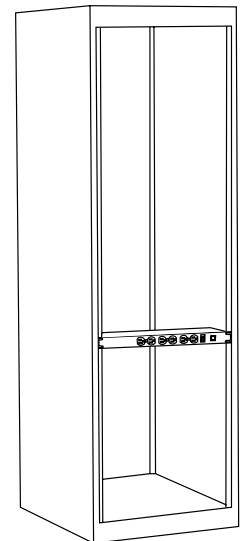

20 Amp Rack Mount (Rear Receptacles)

Part No.	Outlets	On-Off Switch	Pilot Light	Cord Length	Plug Type	Dimensions (Inches)	Electrical Rating	Shipping Weight
1589H6C1BKRR	6	Yes	-	6'	Twist Lock	19 x 3 x 1.75	120VAC/20A	4.2 lbs
1589H6D1BKRR	6	Yes	-	15'	Twist Lock	19 x 3 x 1.75	120VAC/20A	4.5 lbs
1589H6F1BKRR	6	Yes	-	6'	Straight	19 x 3 x 1.75	120VAC/20A	4.0 lbs
1589H6G1BKRR	6	Yes	-	15'	Straight	19 x 3 x 1.75	120VAC/20A	4.5 lbs
1589T6C1BKRR	6	-	Yes	6'	Twist Lock	19 x 3 x 1.75	120VAC/20A	4.2 lbs
1589T6D1BKRR	6	-	Yes	15'	Twist Lock	19 x 3 x 1.75	120VAC/20A	4.5 lbs
1589T6F1BKRR	6	-	Yes	6'	Straight	19 x 3 x 1.75	120VAC/20A	4.0 lbs
1589T6G1BKRR	6	-	Yes	15'	Straight	19 x 3 x 1.75	120VAC/20A	4.5 lbs

Accessories



Hammond Manufacturing Co. Ltd.
394 Edinburgh Rd. North
Guelph, Ontario N1H 1E5 CANADA
© Phone: 519-822-2960 Fax: 519-822-0715



Hammond Manufacturing Co. Inc.
256 Sonwil Dr.
Cheektowaga, NY 14225 USA
Phone: 716-651-0086 Fax: 716-651-0726

International - Rack Mount Power Panels



- ~ Designed for use with IEC power cords.
- ~ All steel housing with black powder coat finish.
- ~ 1 IEC 320 inlet, and 8 IEC 320 outlets.
- ~ Standard 19" rack mount
- ~ Designed for power distribution from front of unit.
- ~ Includes 10A, 220VAC circuit breaker to prevent accidental line overload.
- ~ UL pending.
- ~ CSA Certified.
- ~ TÜV certification pending.

International Rack Mount Power Panels

Part No.	Outlets	Receptacle Location	Inlet Location	On-Off Switch	Pilot Light	Dimensions (Inches)	Electrical Rating	Shipping Weight
1582H8E1BK	8	Front	Rear	Yes	-	19 x 3 x 2	220VAC/10A	4.0 lbs
1582T8E1BK	8	Front	Rear	-	Yes	19 x 3 x 2	220VAC/10A	4.0 lbs
1583H8E1BK	8	Rear	Rear	Yes	-	19 x 3 x 2	220VAC/10A	4.0 lbs
1583T8E1BK	8	Rear	Rear	-	Yes	19 x 3 x 2	220VAC/10A	4.0 lbs

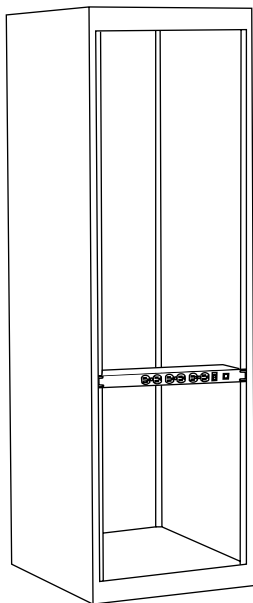



1427C1

- 4" (102mm) hole to hole mounting centers
- 4.4" (111mm) length
- 1.3" (33mm) height
- 3/8" (9.5mm) diameter round bright nickel finished brass
- 10-32 hardware included
- thread depth is 9/16" (14.3mm)



1427C6

- 2.7" (70mm) hole to hole mounting centers
- 3.5" (89mm) length
- 1.5" (38mm) height
- clear anodized satin finish aluminum
- 8-32 hardware included
- thread depth is 7/16" (11.11mm)



1427C2

- 4" (102mm) hole to hole mounting centers
- 4.4" (111mm) length
- 1.3" (33mm) height
- 5/8" x 9/32" (15.9 x 7.14mm) oval, satin nickel finished brass
- 10-32 hardware included
- thread depth is 1/2" (12.7mm)



1427L

- 7" (178mm) hole to hole mounting centers
- 7.4" (187mm) length
- 1.2" (30mm) height
- chrome plated steel
- 10-32 hardware included
- .375" (10mm) diameter



1427C4

- 4.4" (111mm) hole to hole mounting centers
- 5" (127mm) length
- 1" (25mm) height
- black anodized satin finish aluminum
- 8-32 hardware included
- thread depth is 3/8" (9.5mm)



1427M

- 5.3" (133mm) hole to hole mounting centers
- 5.6" (141mm) length
- 1.2" (30mm) height
- chrome plated steel
- 10-32 hardware included
- .375" (10mm) diameter



1427C5

- 4" (102mm) hole to hole mounting centers
- 4.2" (108mm) length
- 1.3" (34mm) height
- 1/4" x 7/8" (6.35 x 22.2mm) rectangular, clear anodized brushed finish aluminum
- 8-32 hardware included
- thread depth is 7/16" (11.11mm)



1427N

- 3.5" (89mm) hole to hole mounting centers
- 3.9" (99mm) length
- 1.2" (30mm) height
- chrome plated steel
- 10-32 hardware included
- .375" (10mm) diameter



Handles



1427P

- 2.8" (71mm) hole to hole mounting centers
- 3" (76mm) length
- .95" (24mm) height
- chrome plated steel
- 6-32 hardware included
- .25" (6mm) diameter



M250-1003

- 4" (102mm) hole to hole mounting centers
- 4.4" (111mm) length
- 1.4" (36mm) height
- black nylon carry handle
- 55 lb. load capacity
- hardware included
- .52" (13mm) diameter



1427Q

- 2.3" (58mm) hole to hole mounting centers
- 2.5" (64mm) length
- .95" (24mm) height
- chrome plated steel
- 6-32 hardware included
- .25" (6mm) diameter



M250-1393

- 5.6" (141mm) hole to hole mounting centers
- 6.1" (154mm) length
- 1.7" (42mm) height
- black nylon carry handle
- 132 lb. load capacity
- hardware included
- .79" (20mm) diameter



M286-6

- 3.9" (99mm) hole to hole mounting centers
- 4.6" (118mm) length
- 1.7" (42mm) height
- spring-locked, chrome plated steel folding handle
- carry capacity of 220 lbs. (100kg) per pair
- hardware included
- sold in pairs



M268-2

- 3.5" (88mm) hole to hole mounting centers
- 4" (102mm) length
- 1.6" (40mm) height
- matte anodized aluminum handle
- hardware included
- .48" (12mm) diameter



M250-663

- 2.7" (67mm) hole to hole mounting centers
- 3" (75mm) length
- 1.3" (32mm) height
- black nylon carry handles
- hardware included



M268-3

- 4.8" (121mm) hole to hole mounting centers
- 5.3" (134mm) length
- 1.6" (40mm) height
- matte anodized aluminum handle
- hardware included
- .48" (12mm) diameter



M268-4

- 7.1" (181mm) hole to hole mounting centers
- 7.6" (194mm) length
- 1.6" (40mm) height
- matte anodized aluminum handle
- hardware included
- .48" (12mm) diameter



M3299-1231

- 3" (75mm) hole to hole mounting centers
- 3.4" (87mm) length
- 1.6" (40mm) height
- matte anodized aluminum handle
- hardware included
- .30" (8mm) diameter



M268-5

- 9.3" (237mm) hole to hole mounting centers
- 9.8" (249mm) length
- 1.6" (40mm) height
- matte anodized aluminum handle
- hardware included
- .48" (12mm) diameter



M3299-1301

- 4.7" (119mm) hole to hole mounting centers
- 5.2" (131mm) length
- 1.6" (40mm) height
- matte anodized aluminum handle
- hardware included
- .30" (8mm) diameter



1427F

- 3.7" (94mm) hole to hole mounting centers
- 4.9" (124mm) length
- 2.2" (56mm) height
- black, scratch resistant, light weight polystyrene handle
- 60 lb. load capacity
- nickel plated steel support posts
- hardware included
- .43" (11mm) diameter



1427J

- 8.5" (216mm) long
- .77" (20mm) width
- .19" (5mm) height
- 7.25" (184mm) mounting centers
- chrome caps on a fluted soft vinyl strap with a spring steel core
- 50 lb. load capacity
- hardware included



M3299-1131

- 1.3" (32mm) hole to hole mounting centers
- 1.7" (42mm) length
- 1.6" (40mm) height
- matte anodized aluminum handle
- hardware included
- .30" (8mm) diameter



1427K

- 5" (128mm) length
- 3.5" (90mm) height
- .68" (17mm) depth
- black plastic tray with grey plastic folding handle
- handle is 4.1" (104mm) wide and 2.5" (63mm) high
- steady load capacity of 75 lbs. per handle
- simple installation: secured by 2 clips (included)



Handles, Feet & Cable Wraps



M262-01

- 5.9" (150mm) length
- 4.1" (105mm) height
- .65" (17mm) depth
- galvanized steel, flush mount screw down tray
- polished aluminum handle
- handle is 4.7" (120mm) wide and 3" (77mm) high
- steady load capacity of 330 lbs. per pair
- hardware included
- sold in pairs



M3784-7001

- 2.6" (67mm) length (in closed position)
- 1.8" (46mm) height (in open position)
- black polyamide spring locked folding legs
- hardware included
- sold in pairs



M263-1

- 5.1" (130mm) length
- 3.6" (91mm) height
- .79" (20mm) depth
- black steel tray
- folding, spring loaded polished steel handle
- handle is 4" (102mm) wide and 2.3" (59mm) high
- steady load capacity of 275 lbs. per pair
- hardware not included
- sold in pairs

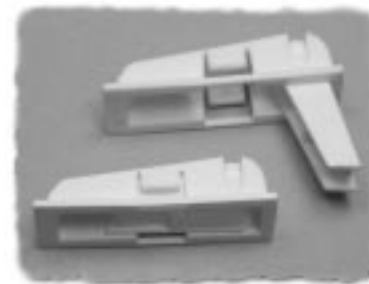

1427X

- 2.5" (63mm) length (in closed position)
- 1.35" (34mm) height (in open position)
- white ABS plastic folding legs
- sold in pairs



M3255-2001

- 7.6" (194mm) length
- 3" (76mm) height
- .83" (21mm) depth
- silver steel tray
- folding black matte handle
- handle is 6.4" (164mm) wide and 2.3" (59mm) high
- carry capacity of 220 lbs. per pair
- hardware not included
- sold in pairs

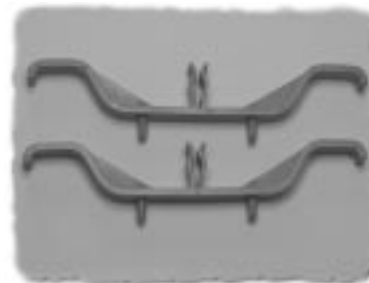

M795

- 4.8" (122mm) overall length
- grey plastic cord wrap
- simple installation: secured by two clips each (included)
- sold in pairs



M797-24

- 1.1" (27mm) length
- .64" (16mm) height
- .55" (14mm) depth
- black polyamic fixed rear legs
- hardware included
- sold in pairs



M795-2

- 5" (126mm) overall length
- zinc plated cord wrap
- mounting hardware not included
- sold in pairs



Part #: **1421**
(package of 4 screws & 4 metal cup washers)

- 10-32 x 0.625"
- Slotted oval head screws
- Steel cup washers (0.60" outside diameter)
- Nickel plated



Part #: **1421E25W**
(package of 25)
Part #: **1421E100W**
(package of 100)

- Metal cup washers
- 0.60" outside diameter
- Use with 10-32 countersunk screws
- Nickel plated



Part #: **1421A**
(package of 4 screws & 4 plastic cup washers)

- 10-32 x 0.625"
- Slotted & Phillips combination oval head screws
- Nickel plated screws
- Black plastic cup washers (0.58" outside diameter)



Part #: **1421A25W**
(package of 25)
Part #: **1421A100W**
(package of 100)

- Black plastic cup washers
- 0.58" outside diameter
- Use with 10-32 countersunk screws



Part #: **1421A25B**
(package of 25)
Part #: **1421A100B**
(package of 100)

- 10-32 x 0.625"
- Slotted & Phillips combination oval head screws
- Nickel plated



Part #: **1421B**
(package of 4 screws & 4 nylon washers)

- 10-32 x 0.5" thumb screws
- With captivated nylon washers
- Nickel plated
- Works with panels up to 0.09" thick
- Head is 0.62" dia. x 0.37" high



Part #: **1421F25**
(package of 25)

- 10-32 x 1.25"
- Phillips oval head screws
- Nickel plated



Part #: **1421D**
(package of 25)

- 10-32 x 0.5"
- Slotted & Phillips combination pan head screws
- Use where economy is important OR for close panel spacing.
- Zinc plated

Accessories



Hardware



Part #: **H1224S20**
(package of 20 screws)

- 12-24 x 5/8"
- Slotted & Phillips combination pan head screws
- Zinc plated
- Used mainly on our aluminum open relay racks (RRAL series)



Part #: **1421CNC25**
(package of 25)
Part #: **1421CNC100**
(package of 100)

- 12-24 cage nuts
- USE ON SQUARE HOLE PUNCHED RAILS ONLY
- Has the holding strength of a 12-24 nut
- Zinc plated



Part #: **1421N25**
(package of 25)
Part #: **1421N100**
(package of 100)

- 10-32 clip nuts
- USE ON ROUND HOLE PUNCHED RAILS ONLY
- Has the holding strength of a 10-32 nut
- Black finish



Part #: **1421CNB25**
(package of 25)
Part #: **1421CNB100**
(package of 100)

- M6 cage nuts
- USE ON SQUARE HOLE PUNCHED RAILS ONLY
- Has the holding strength of a M6 nut
- Zinc plated



Part #: **1421NP25**
(package of 25)
Part #: **1421NP100**
(package of 100)

- 10-32 clip nuts
- USE ON ROUND HOLE PUNCHED RAILS ONLY
- Has the holding strength of a 10-32 nut
- Zinc plated



Part #: **RCNIT**
(cage nut insertion tool)

- Allows for easy installation of cage nuts in square rail hole
- Spring steel tool



Part #: **1421CNA25**
(package of 25)
Part #: **1421CNA100**
(package of 100)

- 10-32 cage nuts
- USE ON SQUARE HOLE PUNCHED RAILS ONLY
- Has the holding strength of a 10-32 nut
- Zinc plated



Part #: **1463S**
(package of 3 bolts, spring nuts & washers)

- 3/8 x 16 spring loaded nuts (for Rack "C" channels)
- 0.75" hex head bolts & washers
- used to mount one rack rail (used in racks with Amhal strut rail mounting)

Accessories

CASTER APPLICATION TABLE

Rack Series	Type	Accepts Caster Models	See Page
DNRR	Light Duty - Welded	1425B, 1425BM, 1425BH	Below
DNRR	Light Duty - Knockdown	1425B, 1425BM, 1425BH	Below
DNRR	Heavy Duty - Welded	Dolly - 1424T	18
DNRR	Heavy Duty - Knockdown	Dolly - 1424T	18
DNRR	Deep Channel - Knockdown	1425B, 1425BM, 1425BH	Below
REFK	Knockdown Rack Cabinet	1425P, 1425PHD	31
C2	All Contempra 2 Rack Cabinets	1425B, 1425BM, 1425BH, CCSTL, CCSTN	47, 61
C3	Contempra 3 (NEMA 12) Rack Cabinet	CCSTL, CCSTN, C3CRS19, C3DRS24	75

LIGHT DUTY CASTERS

- **Light Duty** - 360 lbs. Mfg.'s specified weight capacity (Set of 4)
- **SEE TABLE ABOVE TO CONFIRM APPLICATION**
- Features ball bearing swivel and hard composition wheels
- Standard 3" x 1.75" hole mounting pattern - no drilling required
- Adds only 0.75" to height of cabinet by fitting up inside base of rack
- Wheels are black & 3" wheel diameter
- Includes mounting hardware
- **SOLD IN A SET OF 4**
- Part Number **1425B**



MEDIUM DUTY CASTERS

- **Medium Duty** - 700 lbs. Mfg.'s specified weight capacity (Set of 4)
- **SEE TABLE ABOVE TO CONFIRM APPLICATION**
- Features ball bearing swivel and hard composition wheels
- Standard 3" x 1.75" hole mounting pattern
- Adds only 0.75" to height of cabinet by fitting up inside base of rack
- Wheels are black & 3" wheel diameter
- Includes mounting hardware
- **SOLD IN A SET OF 4**
- Part Number **1425BM**



HEAVY DUTY CASTERS

- **Heavy Duty** - 1,050 lbs. Mfg.'s specified weight capacity (Set of 4)
- **SEE TABLE ABOVE TO CONFIRM APPLICATION**
- Features ball bearing swivel and hard composition wheels
- Standard 3" x 1.75" hole mounting pattern
- Adds only 0.75" to height of cabinet by fitting up inside base of rack
- Wheels are blue & 3" wheel diameter
- Includes mounting hardware
- **SOLD IN A SET OF 4**
- Part Number **1425BH**





GROUND BUS BAR

- Full Length copper bar - mounts vertically 0.13" thick x 0.63" wide
- Mounts to amhal struts of "C2" Contempra racks or REFK racks
- For maximum versatility - contains no holes (other than mounting holes)
- Includes strut mounting hardware

Part Number	Use With Rack (Panel Space)
CBB35	35"
CBB42	42"
CBB49	49"
CBB56	56"
CBB63	63"
CBB70	70"
CBB78	78.75"

GROUND LUGS



- Dual L16 type aluminum lug
- 1 1/8" wide x 1 3/16" long
- Provides excellent grounding
- Accepts wire sizes from 1/0 to 14
- Usually used in conjunction with bus bar (above)
- Packaged individually
- Mounting hardware not included (requires drilling of bus bar)

Part Number	Package Quantity
DNGL	1

LIGHT KIT



- Designed to fit inside the cabinets
- Features a manually operated switch, 115VAC convenience outlet, durable plastic lens (replacement lens below) and 6' power cord (without plug)
- Finished in white
- CSA & UL component recognized
- Installs with 1/4-20 bolts placed through holes (user drilled) in top of cabinet (or use magnet mount below)
- Screws and sealing washers provided
- Uses standard 15 watt - 18" florescent lamps (NOT INCLUDED)
- 1 3/4" high x 4 1/2" deep
- Includes mounting hardware

Part Number	Description
FLK18	18" Florescent Light Kit
FLK18LENS	Replacement plastic lens

LIGHT KIT MAGNET MOUNT



- Designed to allow solid mounting of light kit (above) without drilling
- Also allows light to be easily moved within the rack
- Full length of light kit

Part Number	Description
FLK18MM	Florescent light kit - magnet mount

TOUCH UP PAINT

- For use in matching standard Hammond Mfg. colors
- Supplied in 12 oz. spray cans

Part Number	Color
1413BKLGS	Black - Low Gloss
1413BKS	Black
1413CGRALS	Contempra Beige
1413GFS	Gulf Blue
1413LRS	ASA61 Grey
1413NS	White



LITERATURE POCKET KIT

- Typically applied inside the door or side panels of the rack
- For literature storage
- Kit includes plastic pocket, high strength two-sided adhesive tape and surface preparation swab
- Plastic pocket is black

Part Number	Height	Width
PKT66	6"	6"
PKT99	6"	9"



SIDE PANEL LOCK KIT

- For higher security, the quarter turn fasteners on our side panels can be replaced with this key locking version
- Kit contains 4 quarter turn locks and 8 keys (all keyed alike)
- Good for 1 rack (ie...2 locks per side panel)

Part Number	Use With
CSPQTRL	For "C2" Contempra 2 Rack Side Panels
C3SPQTRL	For "C3" (NEMA 12) Contempra 3 Rack Side Panels



EXTRA CAM FLUSH LOCK

- Quarter turn fastener
- Mounts flush in a 0.760" x 0.655" double D hole or alternately a 0.75" diameter hole
- Kit contains 1 quarter turn lock and 2 keys (all keyed alike)
- Chrome plated brass housing with reversible cam

Part Number	Use With
1427BK	Flush mount doors or panels

